

Tomacorriente

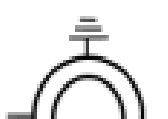

Tomac. de fuerza motriz o calefacción

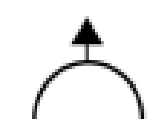

De cuando no se podía ver el símbolo de tierra en los planos



Tomacorriente



Tomac. doble



TUE



Interruptor simple



Interruptor de combinación



Interruptor de 4 vías



"dos teclas en la misma caja"



Interruptor bipolar



"tres teclas en la misma caja"



Interruptor tripolar

Material de la cañería

RS

22

Diámetro de la cañería

2x2,5

+ PE

Conductor de Protección

Cantidad de cables y su sección nominal

IRAM 2010 habla de "acero", "sobre aisladores" y "protegido"

Código

Significado

RS

Acero Semipesado

RL

Acero Liviano

RP

Aislante Rígido Pesado

RSP

Aislante Rígido Semi Pesado

CSP

Corrugado Semipesado

CL

Corrugado Liviano

Propuesta: usemos los códigos de las tablas AEA770.10 VII a IX

Plano

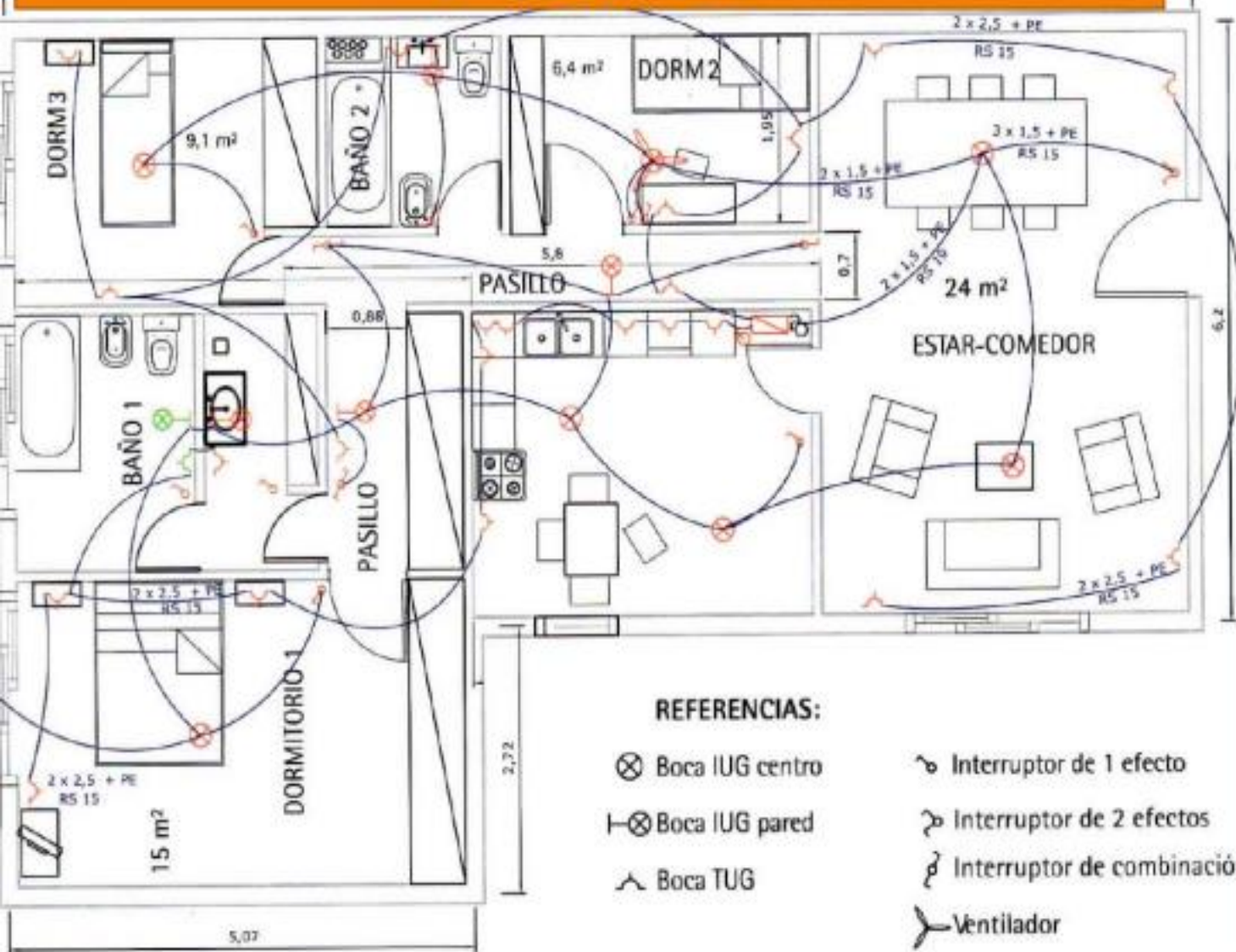

REFERENCIAS:

- ⊗ Boca IUG centro
- ⊗ Boca IUG pared
- ⊗ Boca TUG
- ⌞ Interruptor de 1 efecto
- ⌞ Interruptor de 2 efectos
- ⌞ Interruptor de combinación
- ⌞ Ventilador

Esquema Unifilar

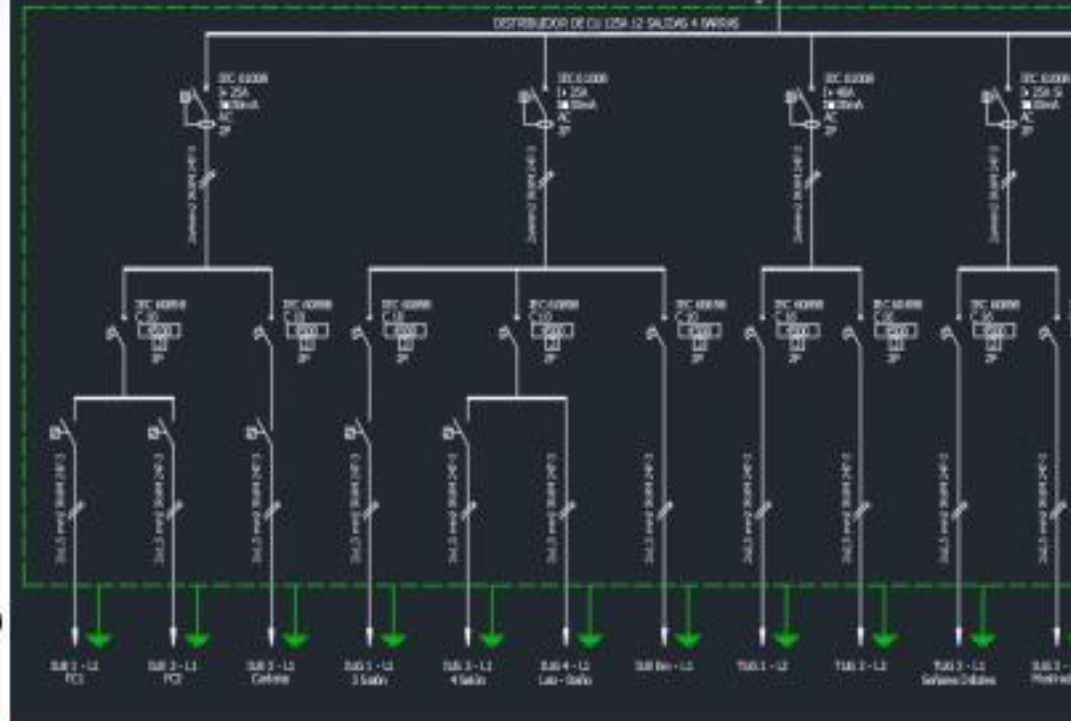

Esquema de montaje

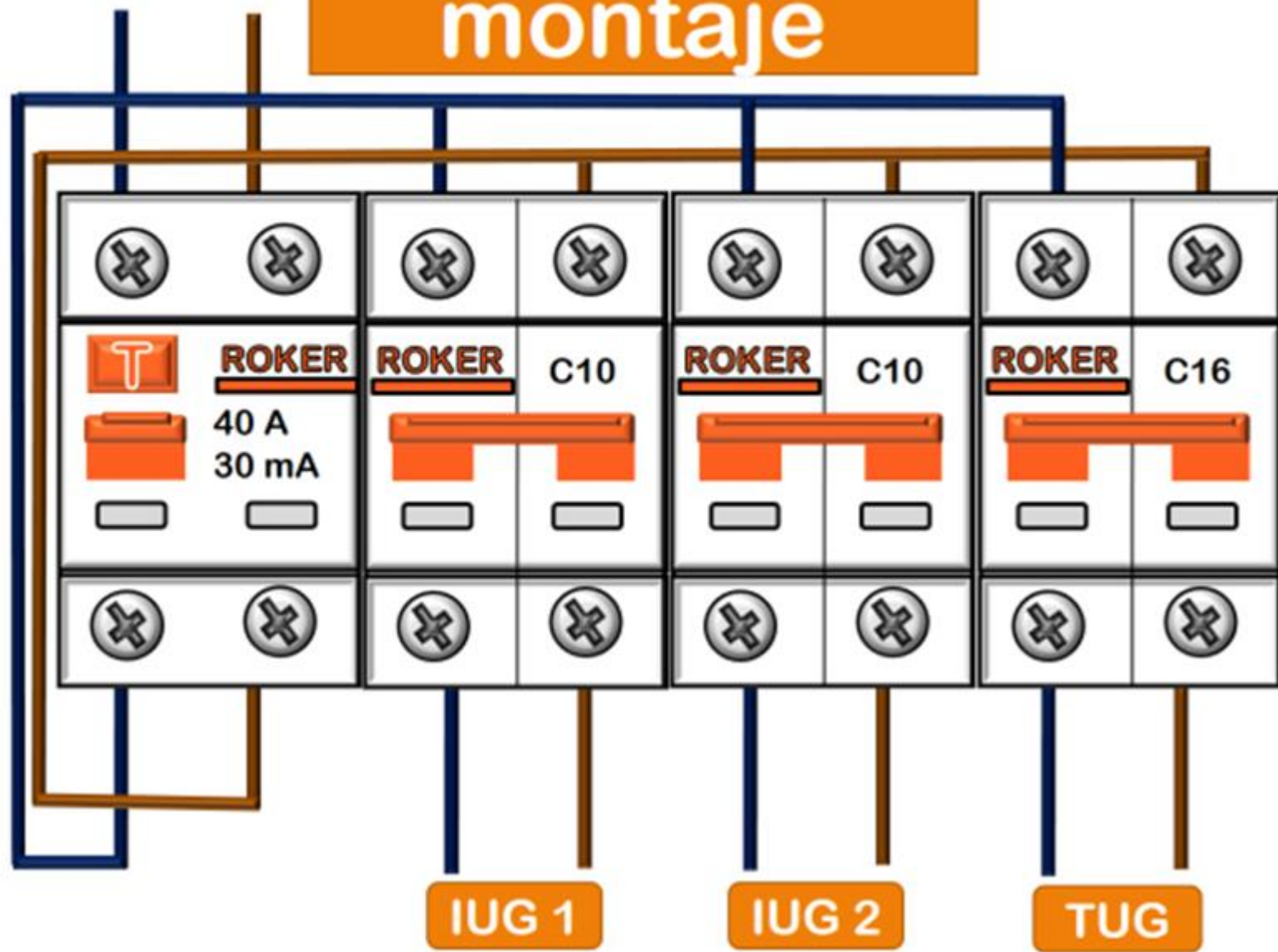

Esquema Unifilar

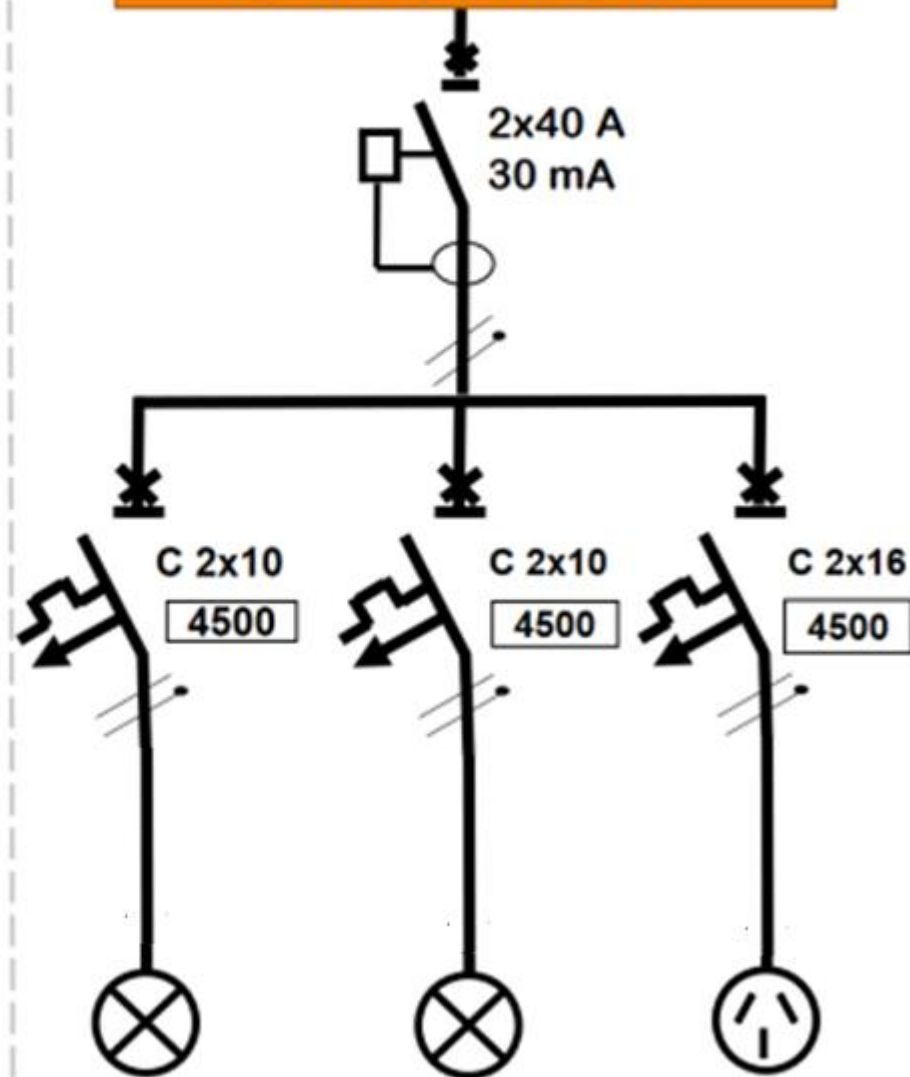

Tablero seccional (TS)

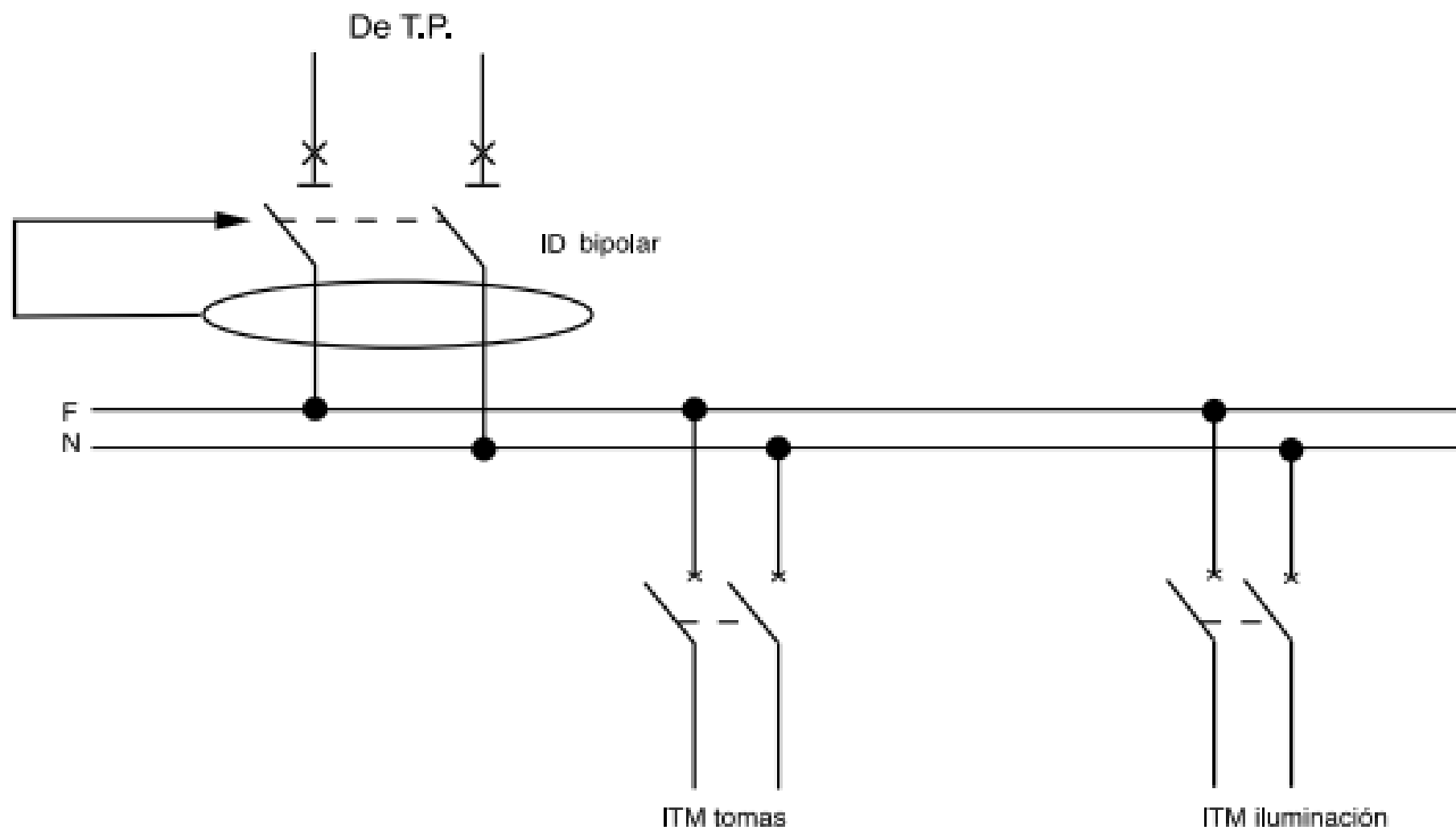

Mirar plano en AutoCAD

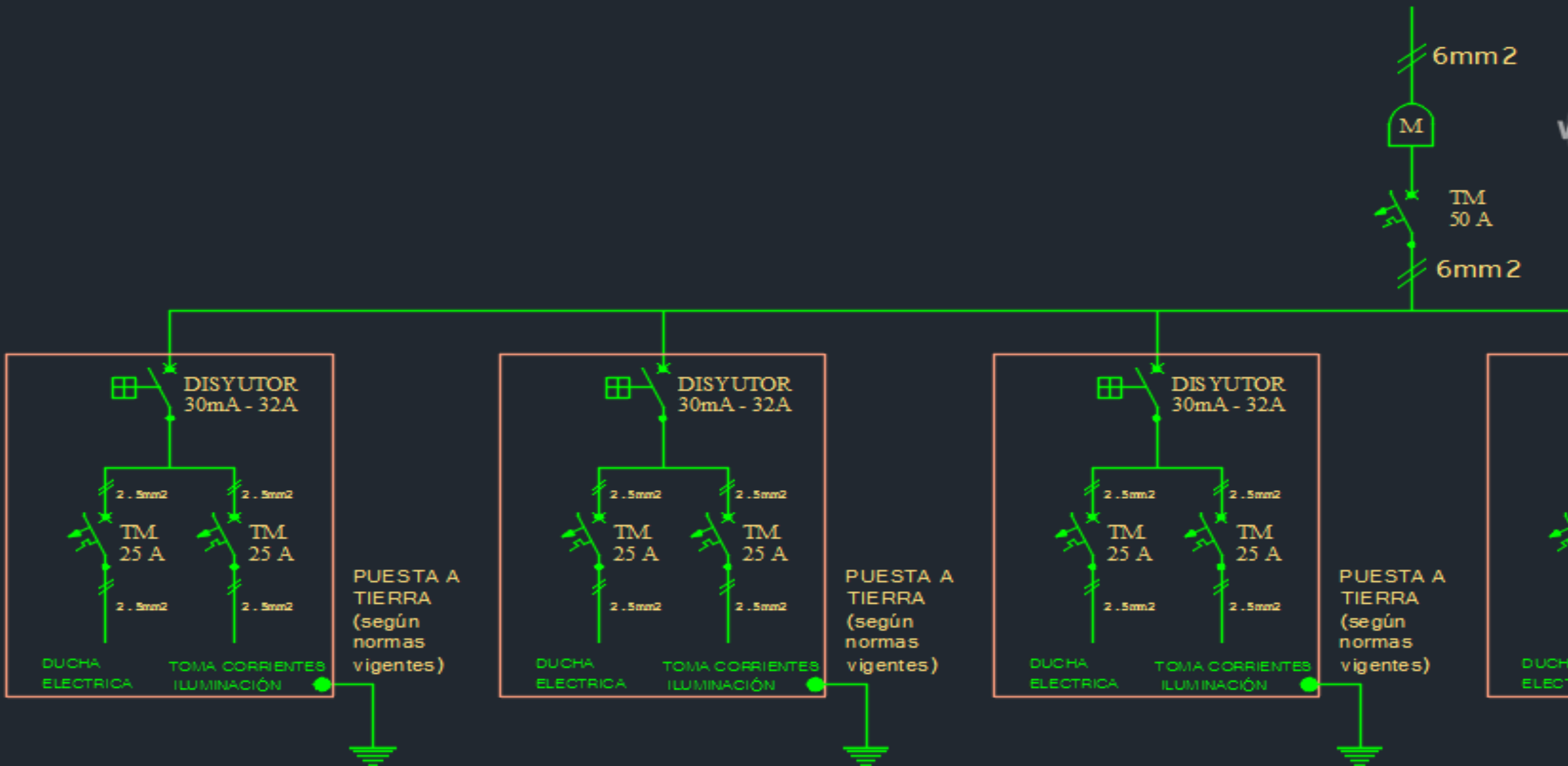

En conjunto, realizar el plano
del esquema unifilar de la
instalación eléctrica
propuesta la clase

PLANOS ELÉCTRICOS INDUSTRIALES

LECTURA E INTERPRETACIÓN

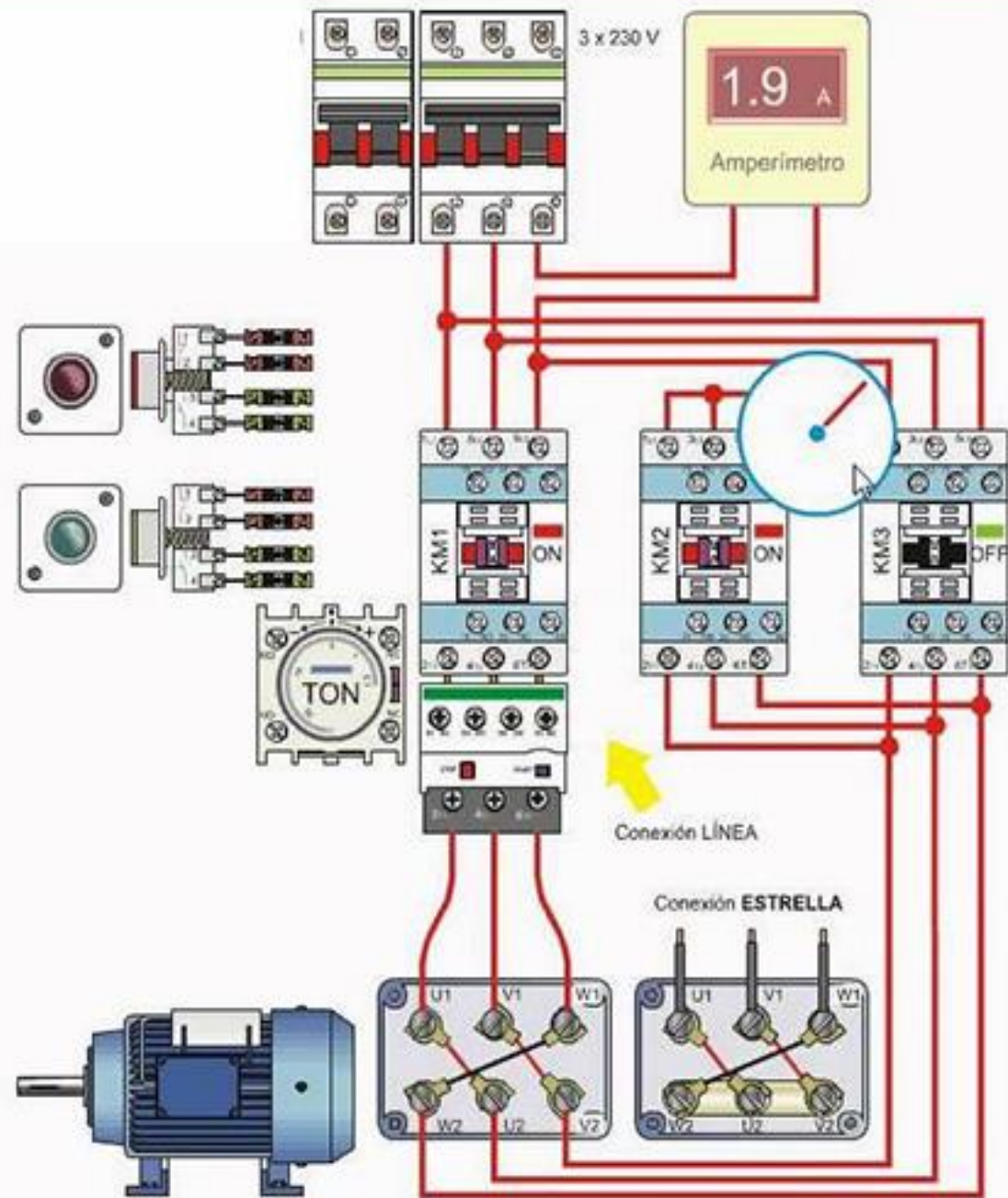

Guía de Productos y Símbolos para Instalación Eléctrica

Materiales permitidos por la Reglamentación para Ejecución de Instalaciones Eléctricas en Inmuebles AEA 90364 – Edición 2006 – de la Asociación Electrotécnica Argentina.

Los productos que se deben instalar en viviendas y locales comerciales deben estar aprobados por la DIRECCION NACIONAL DE COMERCIO INTERIOR y deben tener impreso en su envase o en el material el símbolo correspondiente a la Certificación de Seguridad.



Interrupor Termomagnético norma IEC 60898 o IEC 60947-2 (con regulación fija)

Símbolo:



Aparato:



Datos:

ITM 4
2P 10A
"C" 3kA
IEC 60898

Aparato:



Datos:

ITM 2
4P 32A
"C" 6kA
IEC 60898

Aparato:

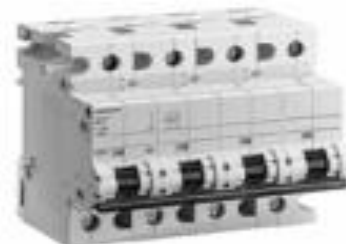

Datos:

ITM 1
4P 100A
"D" 15kA
IEC 60947-2

Interrupor Diferencial según norma IEC 61008

Símbolo:

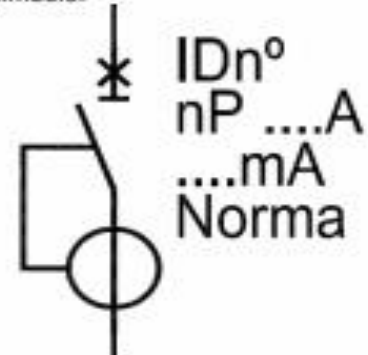

Aparato:



Datos:

ID 2
2P 25A
30mA
IEC 61008

Aparato:



Datos:

ID 5
4P 63A
30mA
IEC 61008

Aparato:



Datos:

ID 3
4P 63A
300mA
Selectivo
IEC 61008

Interrupor Automático norma IEC 60947-2 (con regulación variable)

Símbolo:



Aparato:



Datos:

IA 2
4P 400A
Ir=0,8...1In (0,9 In)
Im=5...10In (5 In)
Ue=690V
Icu/Ics=50/50kA
IEC 60947-2

Contactor y Relé Térmico norma IEC 60947-4

Símbolos:

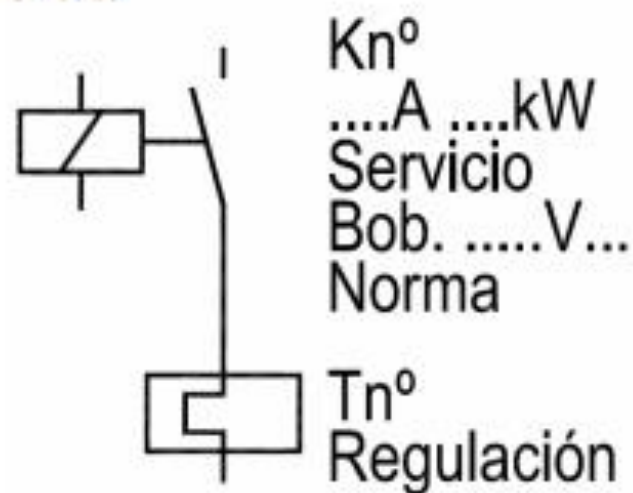

Aparatos:



Datos:

K 3
18A 7,5kW
AC3
Bob.24Vca
IEC 60947-4

T 3
R: 12...18 A

Interruptor Seccionador según norma IEC 60947-3 ("Interruptor Manual")

Símbolo:



Aparato:



Datos:

IS 1
4P 100A
AC-22
IEC 60947-3

Aparato:



Datos:

IS 5
2P 100A
AC-22
IEC 60947-3

Aparato:



Datos:

IS 3
4P 160A
AC-22
IEC 60947-3

Fusible Interruptor-Seccionador norma IEC 60947-3 ("Seccionador Bajo Carga")

Símbolo:



Aparato:



Datos:

FIS 1
3P Ie=160A
IEC 60947-3
Fus NH-T0 100A "gL"
IEC 60269

Aparato:



Datos:

FIS 3
4P Ie=250A
IEC 60947-3
Fus NH-T1 200A "gL"
IEC 60269

NOTA: El profesional podrá agregar otra información necesaria para su instalación.

Guardamotor Magneto-térmico (GMT) según norma IEC 60947-2 / 4-1

Simbolo:

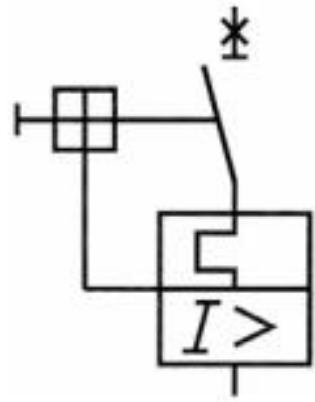

GMTn°
Disparos
Icu/Ics=.....
Clase.....
Norma IEC

Aparato:



Con Comando Rotativo

Datos:

GMT 1
R: 1,6-2,5A
Im= 33,5A
Clase 10/AC3
Icu/Ics=100kA
IEC 60947-2/4-1

Aparato:



Con Comando Pulsadores

Datos:

GMT 1
R: 9-14A
Im= 170A
Clase 10/AC3
Icu/Ics=15/40kA
IEC 60947-2/4-1

Interruptor Horario (IH) según norma IEC 60730 / IEC 60669-1



Esquemas típicos de conexión

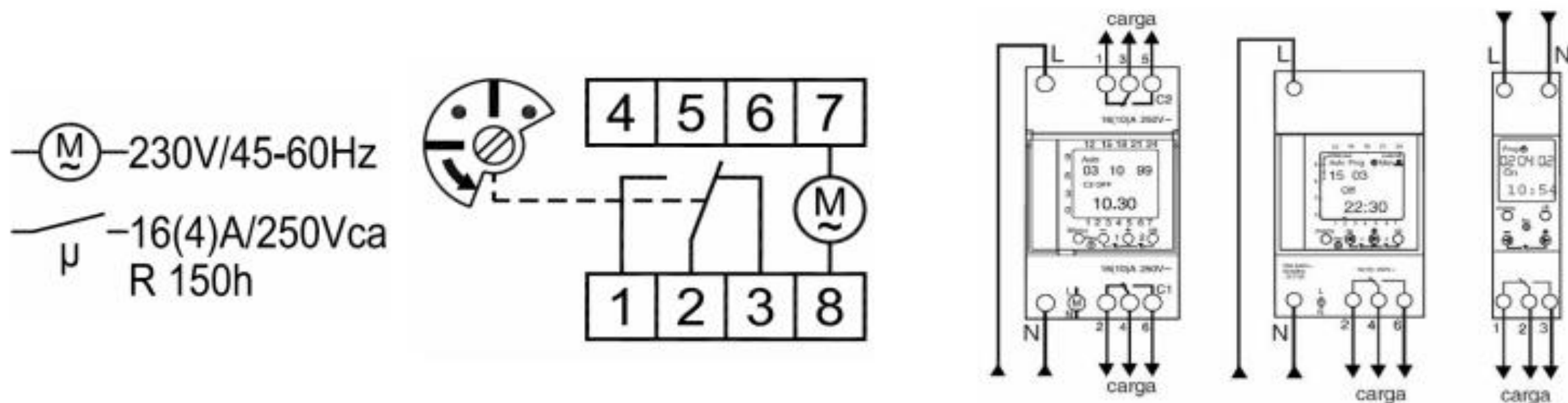

Interruptor fotoeléctrico / Fotocontrol (FC) según norma IRAM-AADL J 2024 / 2025

| | | |
|---|---|--|
| <p>Simbolo:</p>  | <p>Aparato:</p>  | <p>Aparato:</p> <p>Fotocontrol</p>  <p>Zocalo</p>  |
|---|---|--|

Datos y Esquema típico de conexión

Tensión: 195 ... 270 V
Capacidad de carga: 10 A
Frecuencia: 50/60 Hz
Nivel de encendido: 10 Lux
Nivel de apagado: 50 Lux
Retardo: 10-90 segundos
Consumo: 1,5 W
Temperatura: -30°C a 70°C

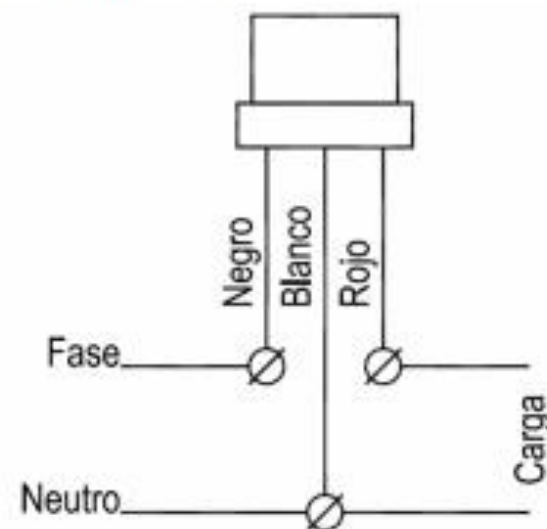

EJEMPLO REFERENCIA PARA PLANO:

16A (IP67)



Tomacorriente trifásico 3P+N+T 16A-380V IP67 (norma IEC 60309)

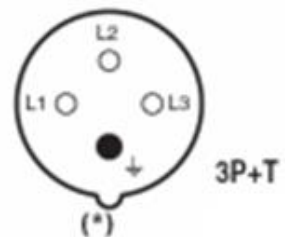
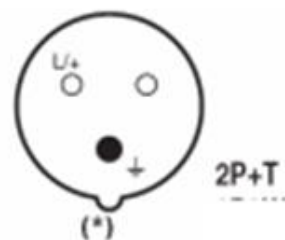

CODIGO DE COLORES

Las diferentes tensiones de trabajo se distinguen por los distintos colores convencionales indicados en la tabla:

| Tensión nominal de trabajo V | Colores ¹⁾ |
|------------------------------|-----------------------|
| da 20 a 25 | Violeta |
| da 40 a 50 | Blanco |
| da 100 a 130 | Amarillo |
| da 200 a 250 | Azul |
| da 380 a 480 | Rojo |
| da 500 a 690 | Negro |

1) Para frecuencias de 60Hz a 500Hz inclusive, se puede utilizar si es necesario, el color verde en combinación con el color de la tensión nominal de trabajo.



Plano de diagrama de arranque de un motor de una sierra circular



Diagrama de dibujo

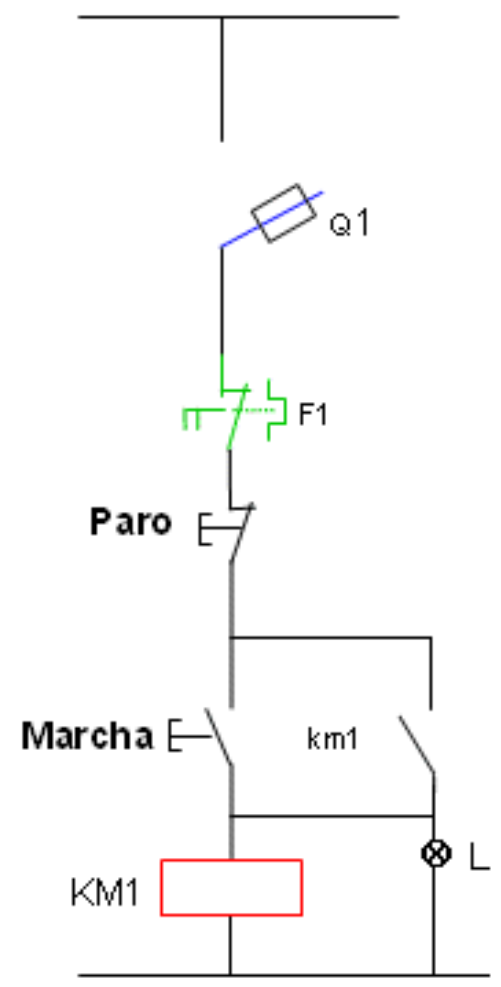
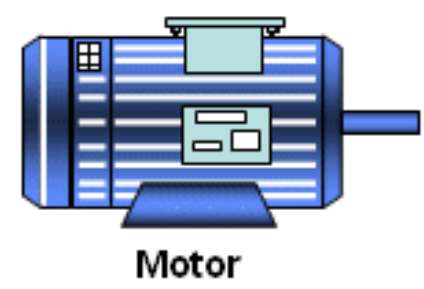
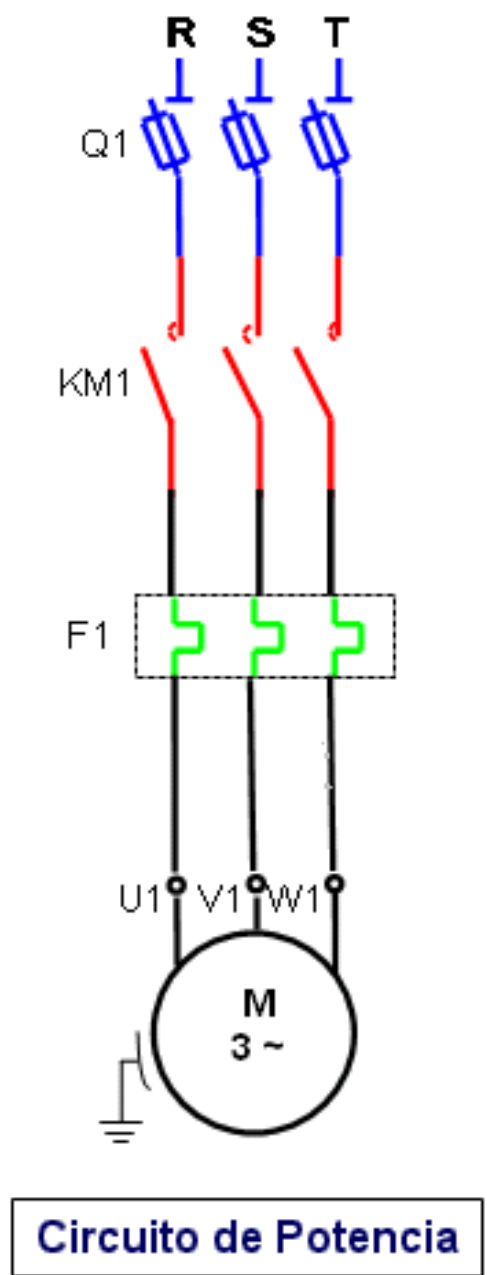

Circuito de Mando

Circuito de comando

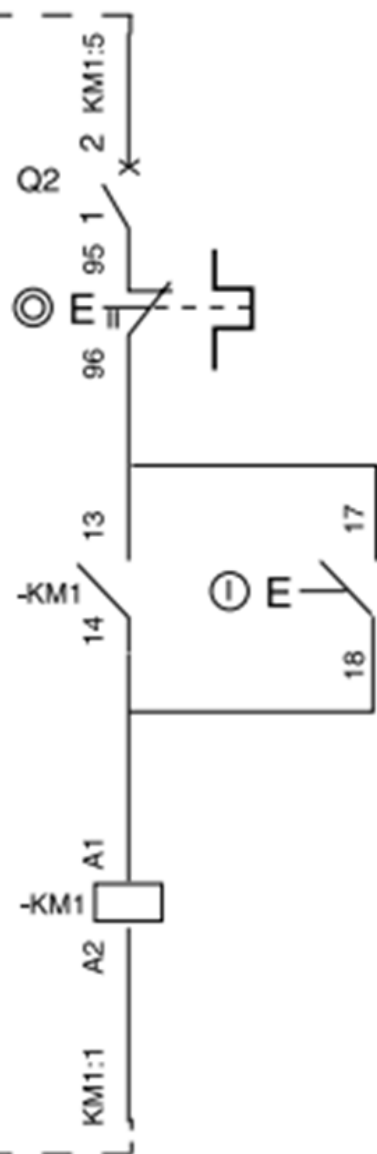

Arranque directo con motor trifásico

Circuito de potencia

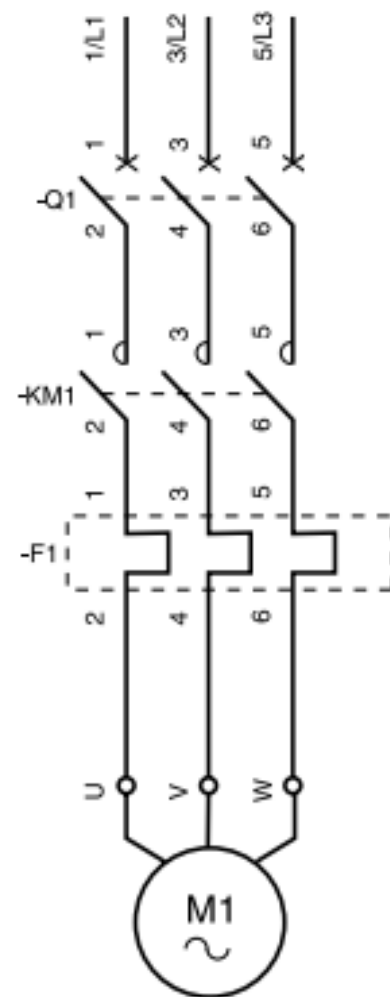

Representación
Trifilar

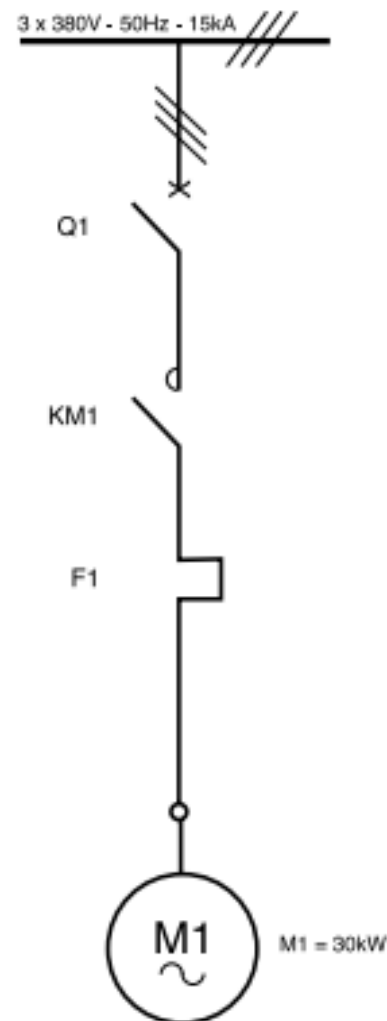

Representación
Unifilar

Diagrama de dibujo / Inversor de Marcha

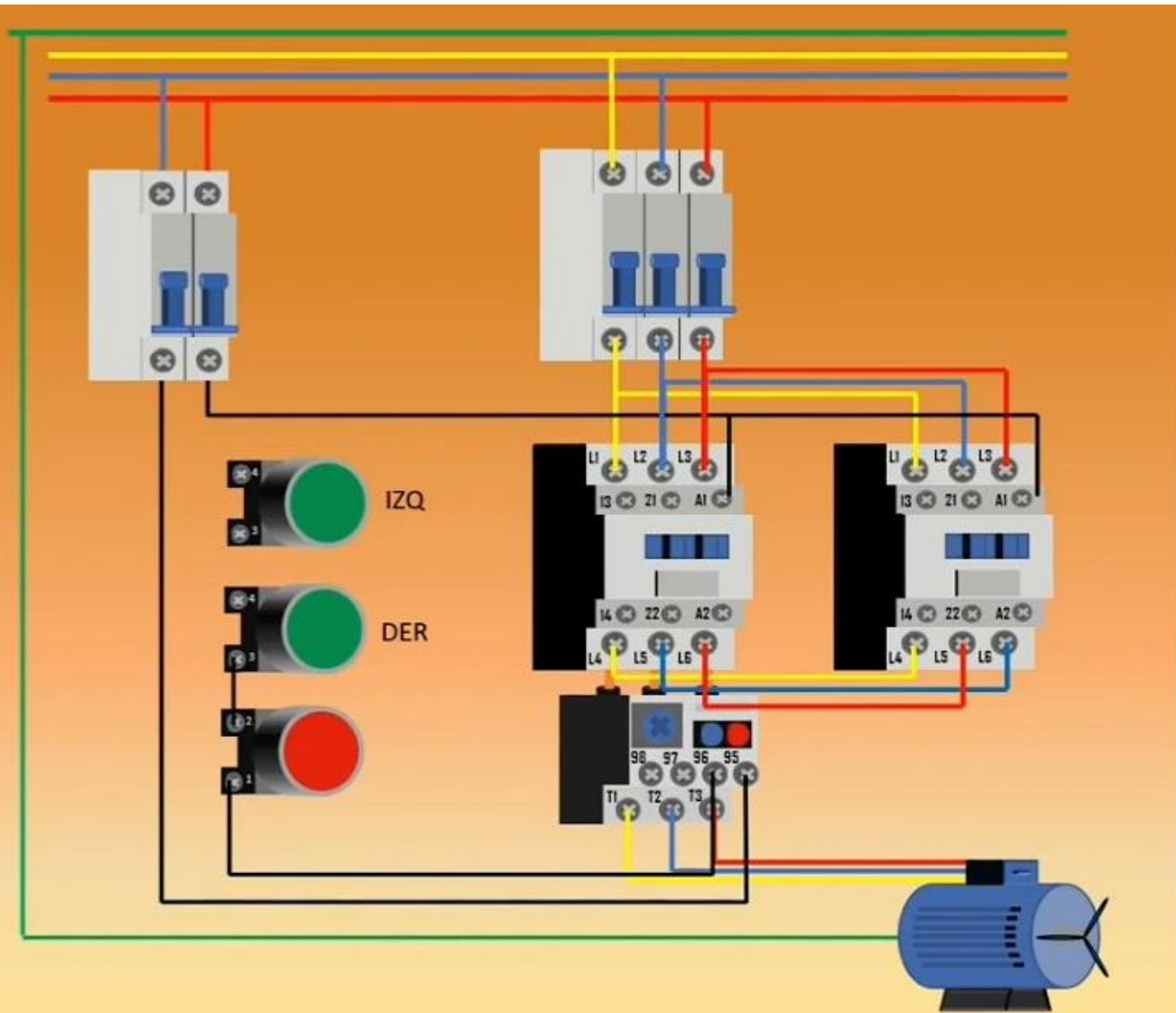

Circuito de mando

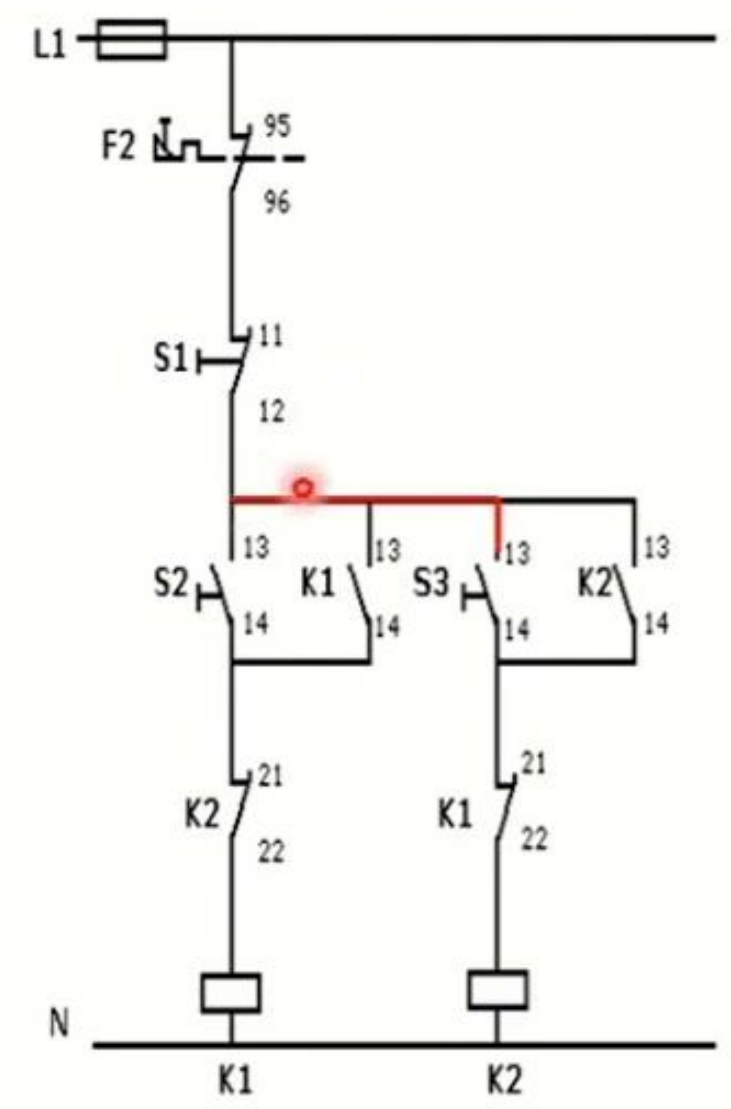

Circuito de comando

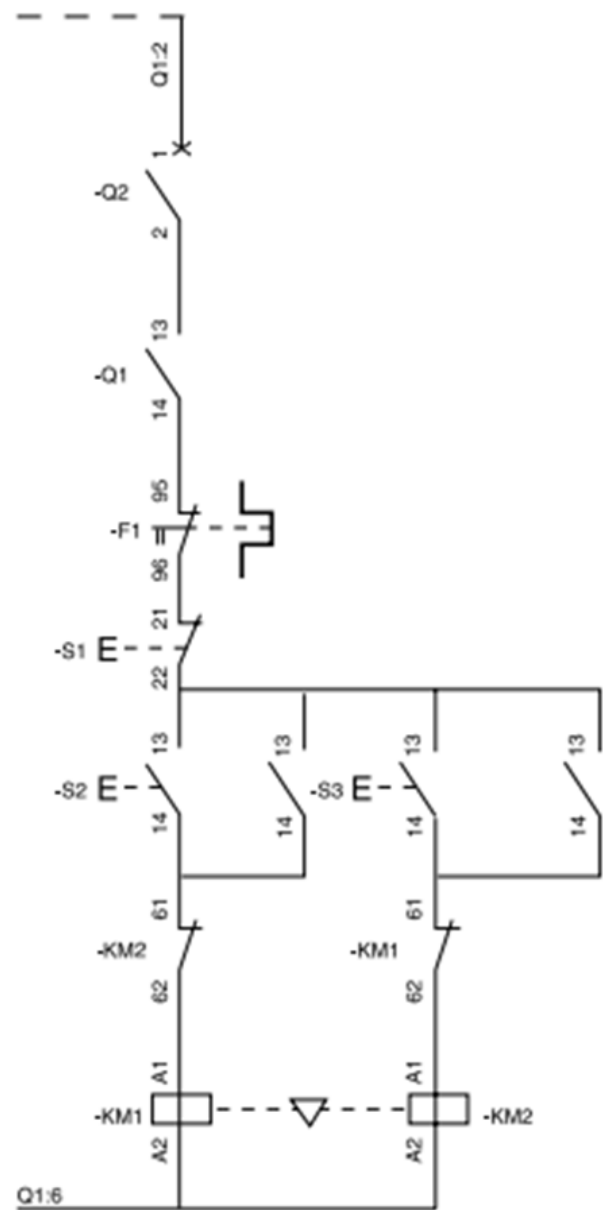

Arranque de un inversor de marcha

Circuito de potencia

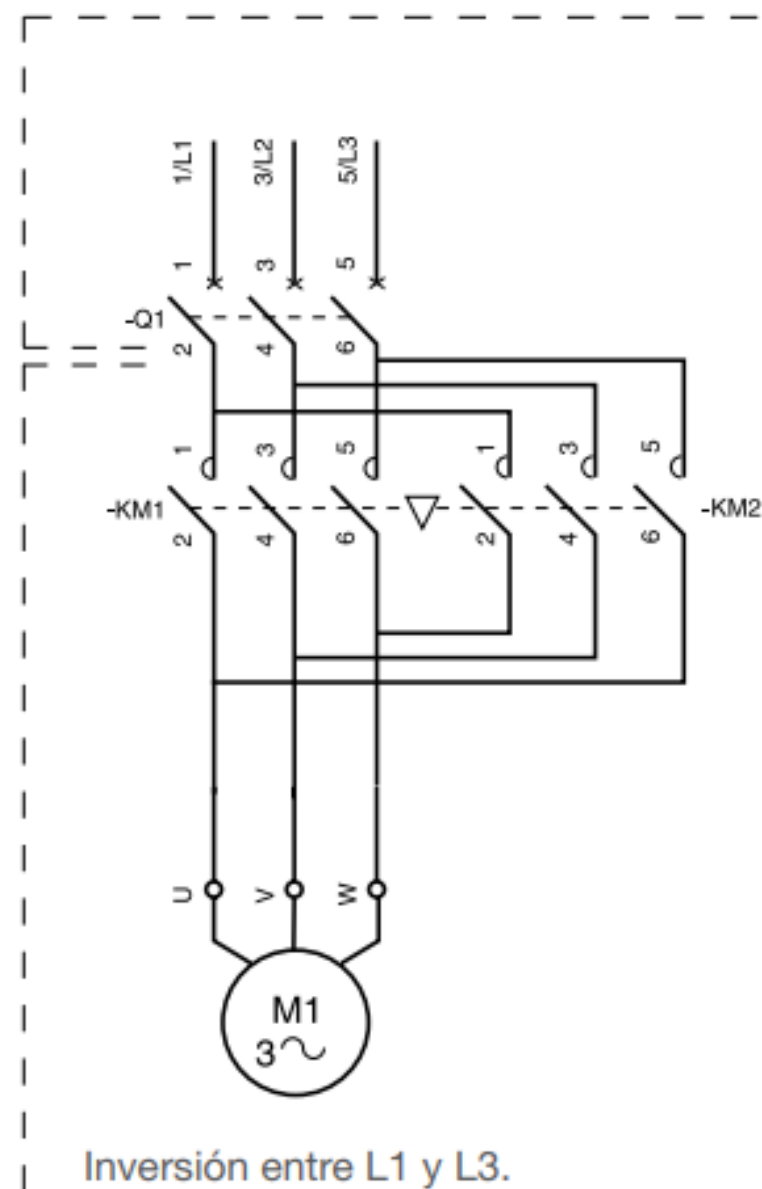

SIMBOLOGÍA NORMALIZADA

Designación de las corrientes

Corriente alterna



Corriente continua



Corriente ondulada o rectificada



Corriente alterna trifásica 50 Hz



Puesta a tierra



Puesta a masa

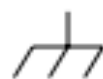

Tierra de protección



Contactos

Seccionador



Contactor



Ruptor



Disyuntor



Designación de los conductores

Conductor circuito auxiliar



Conductor circuito principal



Haz de 3 conductores

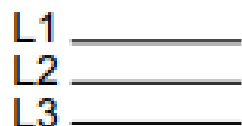

Representación unifilar



Conductor neutro



Conductor de protección



Conductores blindados (apantallados)



Conductores trenzados

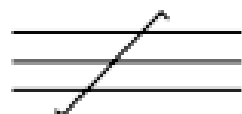

Guardamotor



Interruptor seccionador



Interruptor seccionador con
apertura automática



Seccionador fusible



Contacto de dos direcciones
sin solapado (apertura antes
que el cierre)



Conductores trenzados

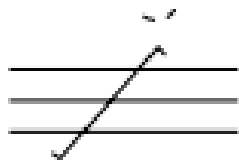

Contacto de dos direcciones sin solapado (apertura antes que el cierre)



Contactos

Contacto cierre NA (símbolo general)

- 1) principal
- 2) auxiliar

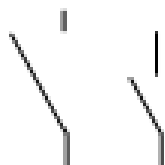

Contactos de dos direcciones solapados



Contacto apertura NC (símbolo gral.)

- 1) principal
- 2) auxiliar

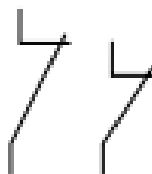

Contactos de dos direcciones con un punto central en posición de apertura

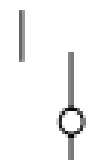

Interruptor (símbolo general)



Contactos representados en posición «accionado»



NA = normalmente abierto. NC = normalmente cerrado.

Contactos (cont.)

Contacto adelantado
actúa antes
que los otros contactos de un
mismo conjunto

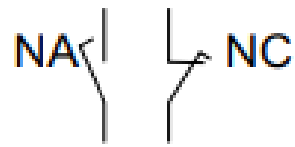

– de un relé polarizado

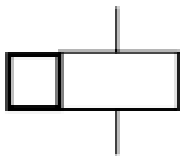

– de corriente alterna

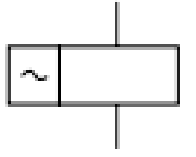

Contacto retardado
actúa más
tarde que los otros contactos
de un mismo conjunto

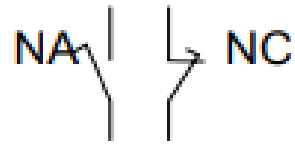

– de un relé intermitente

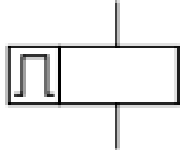

Contacto de paso
– cierre momentáneo al trabajo



– de un relé de impulso

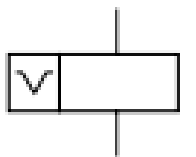

– cierre momentáneo al reposo



– de acción y reposo retardados

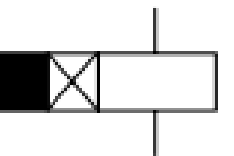

Contacto nomamente abierto
de posición



Relé de medida o dispositivo
semejante (símbolo general)

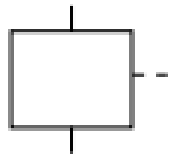





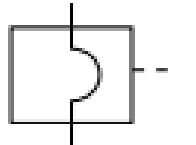

Interruptor de posición

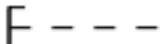
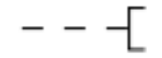
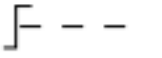

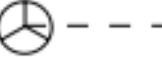
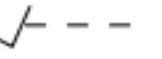
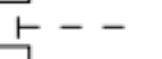
– de sobreintensidad
de efecto magnético



| | |
|-------------------------------------|--|
| – por pulsador (retorno automático) |  |
| – por tirador (retorno automático) |  |
| – rotativo (de enganche) |  |
| – de seta |  |
| – por volante |  |
| – por pedal |  |
| – de acceso restringido |  |
| – por palanca |  |
| – por palanca con maneta |  |
| – por llave |  |

– limitada en ambos sentidos



Mandos eléctricos

Mando por roce

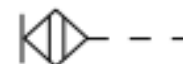

– sensible a la proximidad de un imán



– sensible a la proximidad de un imán

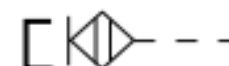

– sensible a la proximidad del hierro



Otros tipos de mando

Neumático o hidráulico
– de simple efecto

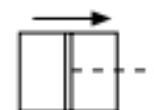

– de doble efecto

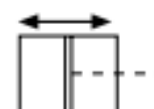

Materiales o elementos diversos

Fusibles



Fusible con percutor



Rectificador



Puente rectificador



Tiristor



Condensador



Pila o acumulador



Resistencia



Shunt



Pararrayos



Arrancador



Arrancador estrella-triángulo



Aparato indicador
(símbolo general)

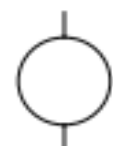

– amperímetro

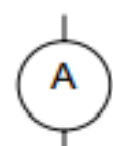



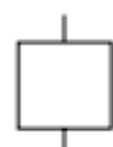



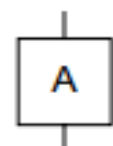

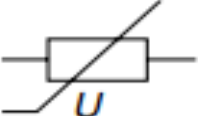

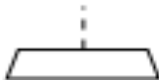

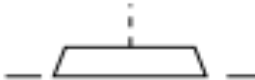
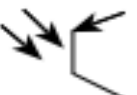
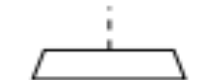
Aparato registrador
(símbolo general)

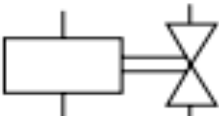

– amperímetro registrador

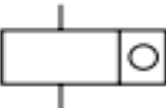

| | | | |
|------------------------------|---|----------------------------|---|
| Varistancia |  | - amperios/hora |  |
| Fotoresistencia |  | Freno (símbolo general) |  |
| Fotodiodo |  | - con freno bloqueado |  |
| Fototransistor (tipo PNP) |  | - con freno liberado |  |
| Transformador de tensión |  | Válvula |  |
| Autotransformador |  | Electro-válvula |  |
| Transformador de intensidad |  | Reloj |  |
| Limitador de sobretensiones |  | Contador de impulsos |  |

Materiales o elementos diversos (cont.)

Detector sensible al roce



Detector de proximidad

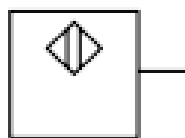

Detector de proximidad inductivo

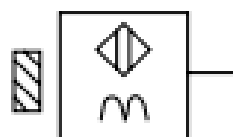

Detector de proximidad capacitivo

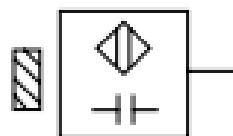

Detector fotoelectrónico sistema reflex

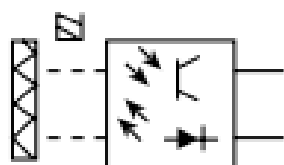

Bocina, claxon

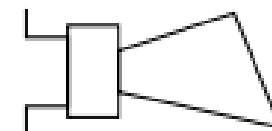

Timbre



Sirena

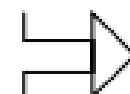

Zumbador



Bornes y conexiones

Derivación



Máquinas eléctricas giratorias

Motor asíncrono trifásico
– de jaula



– de 2 arrolamientos
estatóricos separados

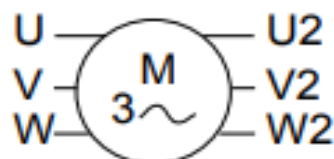

– de 6 bornas de salida
(acoplamiento estrella-triángulo)



– de polos conmutables
(motor de 2 velocidades)

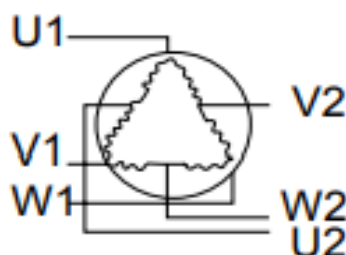

Motor asíncrono trifásico,
motor de anillos



Máquinas eléctricas giratorias (cont.)

Generatriz de corriente alterna



Generatriz de corriente continua



Conmutatriz
(trifásica/continua)
con excitación en derivación

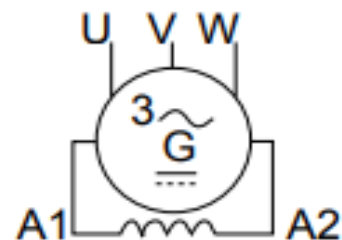

Motor de corriente continua
con excitación independiente

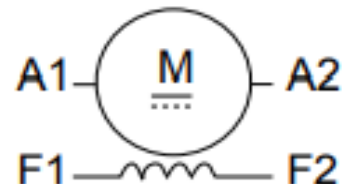

Motor de corriente continua
con excitación compuesta

