

TECNOLOGÍA ELECTRÓNICA

ET242

CAPACITORES

EL CAPACITOR

COMO COMPONENTE ELECTRÓNICO

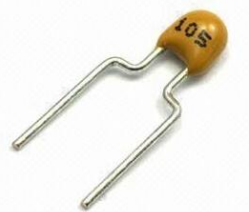

Facultad de **Ingeniería**
OBERA



Universidad Nacional de Misiones

PARTE 4 de 5

CAPACITORES VARIABLES

Mgter. Ing. Victor Hugo Kurtz

CAPACITORES VARIABLES

Capacitor

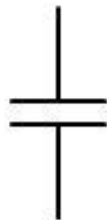

Capacitor electrolítico

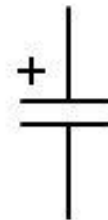

Capacitor variable

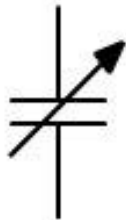

Capacitor (variable) ajustable

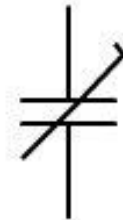

CAPACITORES VARIABLES

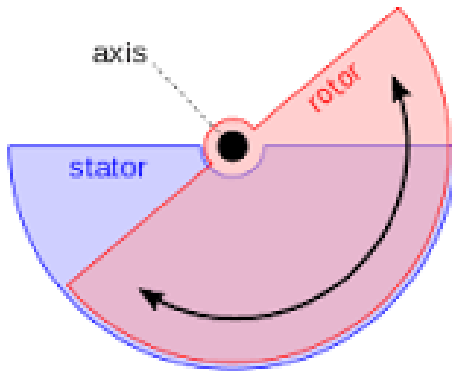

CAPACITORES VARIABLES

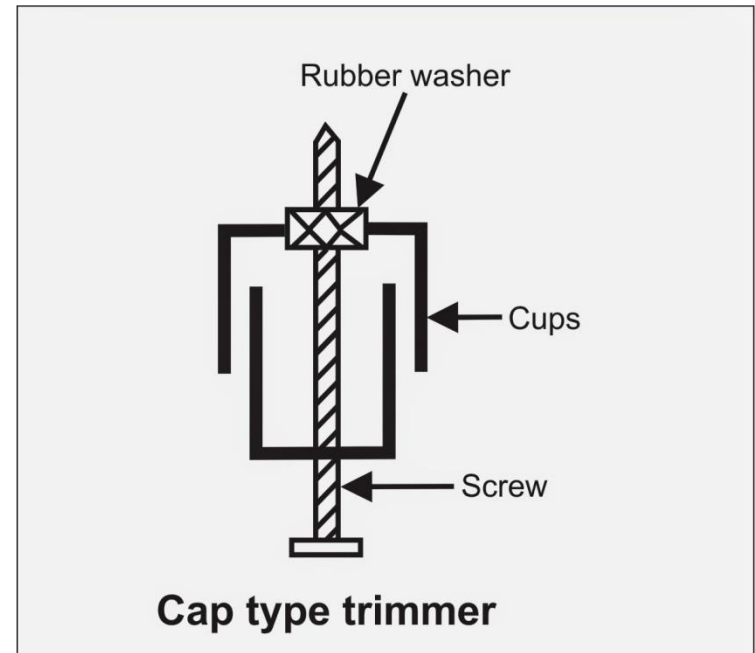
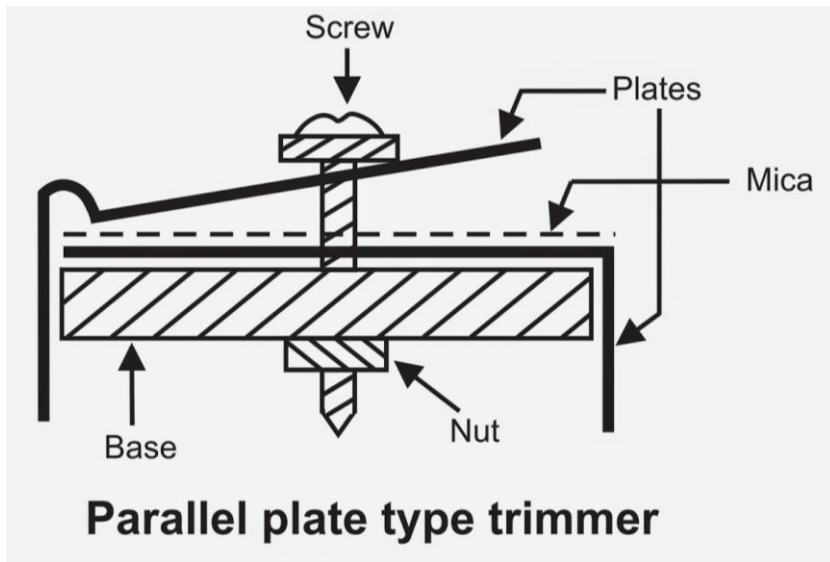

CAPACITORES VARIABLES

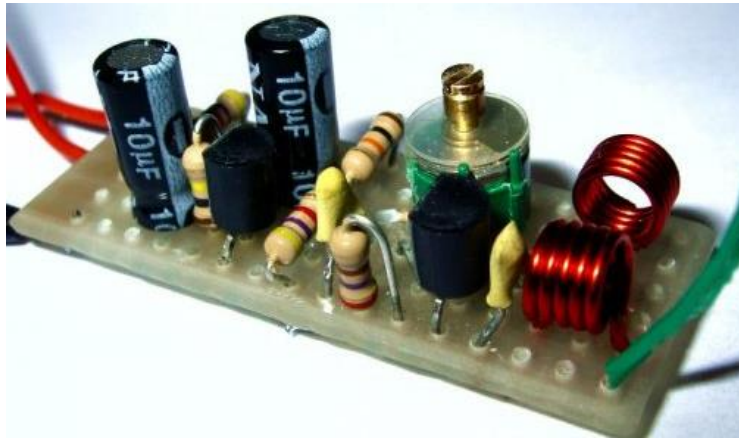

CAPACITORES VARIABLES

COLOR	CODIGO DEL COLOR DEL TRIMMER	VALOR EN PICOFARADIOS
	TR AZUL Z050	(1.5 A 5 PF) NPO
	TR AZUL Z070	(2 A 7 PF) NPO
	TR AZUL Z100	(2.7 A 10 PF) NPO
	TR BLANCO	(2.1 A 10 PF) N200
	TR MARRÓN	(9.8 A 60 PF) N1200
	TR NARANJA	(6 A 50 PF) NPO
	TR NEGRO	(10 A 120 PF) N750
	TR ROJO	(4.2 A 20 PF) N750
	TR ROSA	(4.2 A 20 PF) N450
	TR VERDE	(5.2 A 30 PF) N750
	TR AMARILLO	(6.8 A 45 PF) N1200

CAPACITORES VARIABLES

Miniature Trimmer Capacitors

Polypropylene



Specifications:	
Operating Voltage	150Vdc
Operating Temperature Range	-25°C to +70°C
Body Colour	Red, Yellow, Green, Grey and Violet
Subject to technical modifications.	

PCB mounting, single turn trimmers, with polypropylene dielectric. Available in nine colour coded values.

	Value	Body Colour	Diameter (mm) Ø	Pins	Order Code	1	25+	50+	
	2.0 - 22pF	Green	8.0	3	894-015	0.80	0.75	0.70	
	4.0 - 20pF	Green	8.0	3	894-016	0.93	0.8354	0.7426	
	5.5 - 65pF	Yellow	11.0	3	894-025	1.82	1.6344	1.4528	
	7.0 - 100pF	Violet	10.0	3	894-028	1.90	1.8393	1.7759	

Ceramic



Specifications:	
Operating Voltage	100Vdc (50Vdc 6-50pF)
Temperature Coefficient	±300ppm/°C (±200 1.5-5pF)
Operating Temperature Range	-25°C to +85°C
Q min @ 1MHz	500 (300 1.5-5, 6-50pF)
Body Colour	Blue, White, Red, Green and Orange
Subject to technical modifications.	

Low profile PCB mounting, single turn ceramic trimmers with plastic cases. Available in five colour coded values.

	Value	Body Colour	Diameter (mm) L x Ø	Pins	Order Code	1	25+	50+	
	4.2 - 20pF	Red	5.0 x 6.0	2	895-025	0.32	0.2883	0.256	
	5.2 - 30pF	Green	5.0 x 6.0	2	895-030	0.32	0.2862	0.2544	
	6.0 - 50pF	Orange	5.0 x 6.0	2	895-040	0.78	0.702	0.624	

CAPACITORES VARIABLES



FIN

