



Universidad Nacional de Misiones



Facultad de Ingeniería
OBERA

DIODO SEMICONDUCTOR

Unión P-N

ELECTRÓNICA GENERAL

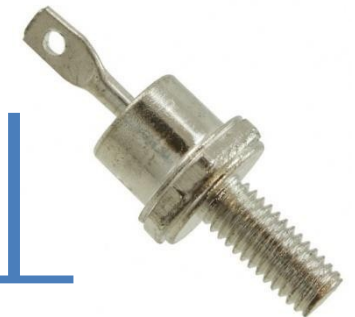
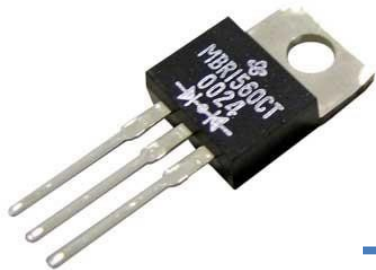
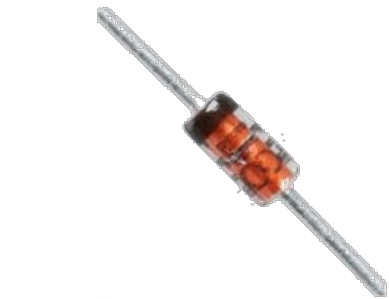

Mgtr. Ing. Victor Hugo Kurtz - 2021

UNION P-N

Región de Agotamiento

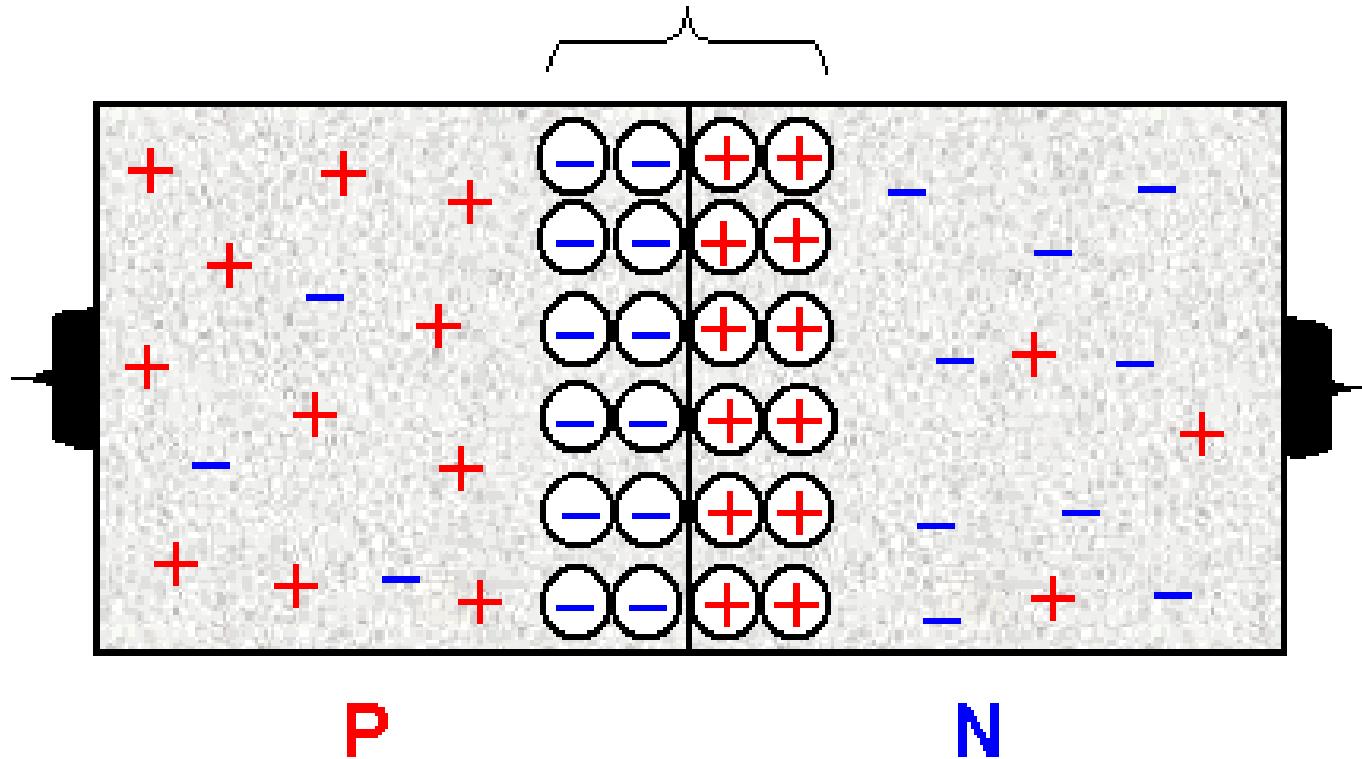

POLARIZACIÓN DIRECTA DE LA UNIÓN PN

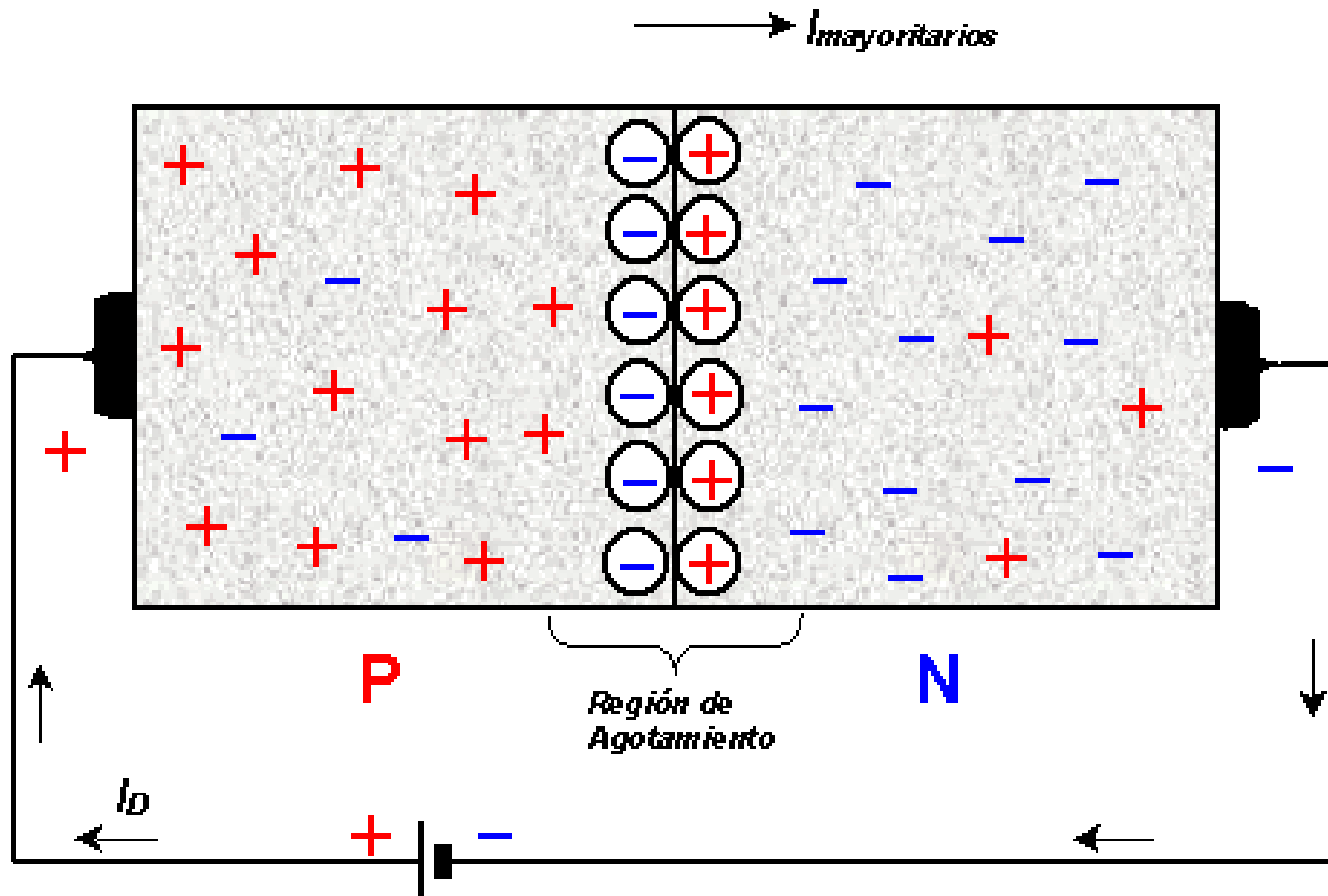

PERMITE La Circulación de Corriente Eléctrica

POLARIZACIÓN EN INVERSA DE LA UNIÓN PN

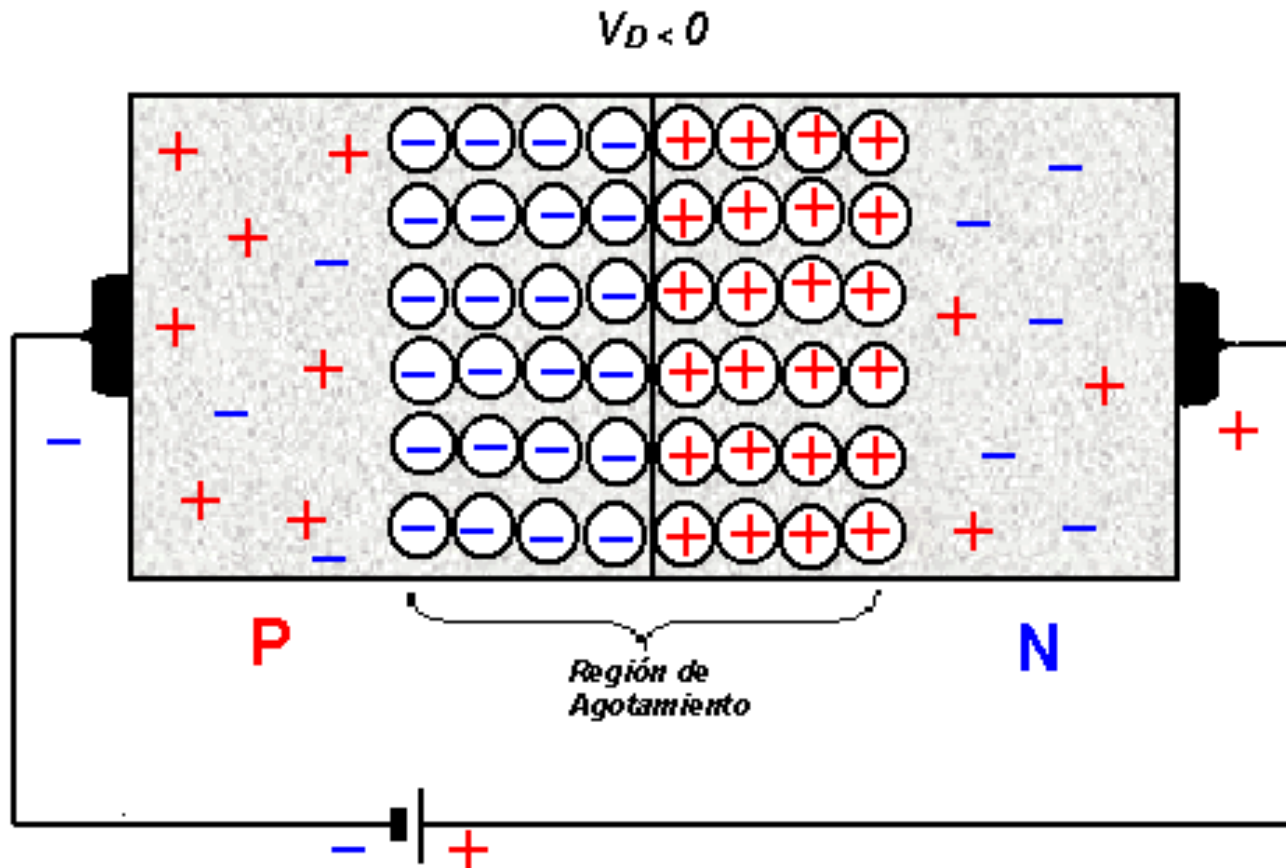

NO PERMITE (Bloqueo) La Circulación de Corriente Eléctrica

REPRESENTACIÓN GRAFICA de Componentes Eléctricos

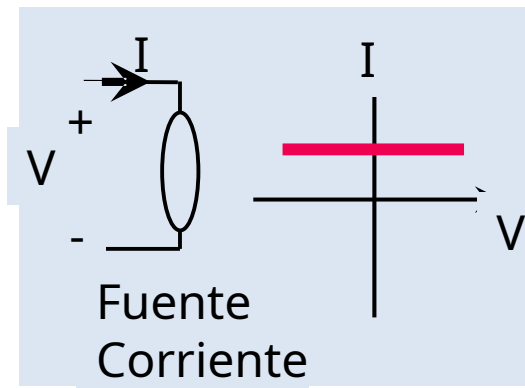
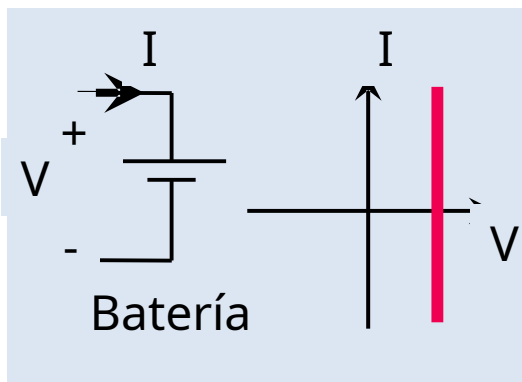
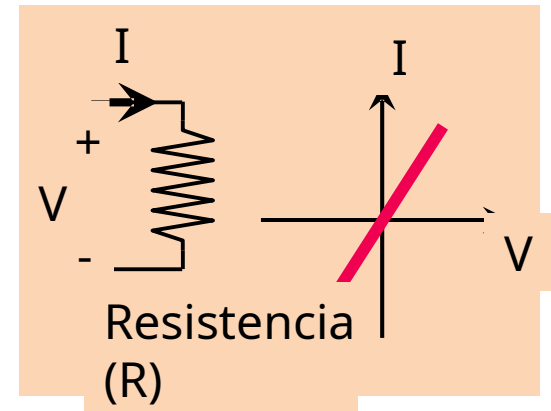
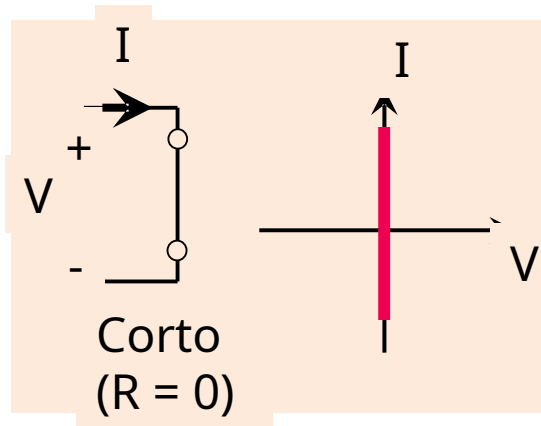
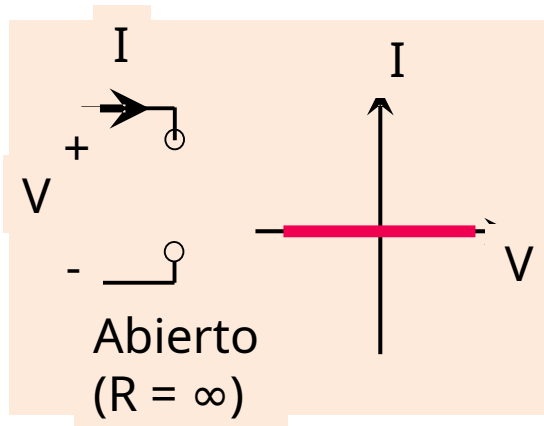

CARACTERÍSTICA DEL DIODO

El DIODO, es un dispositivo que permite el paso de la corriente en un solo sentido

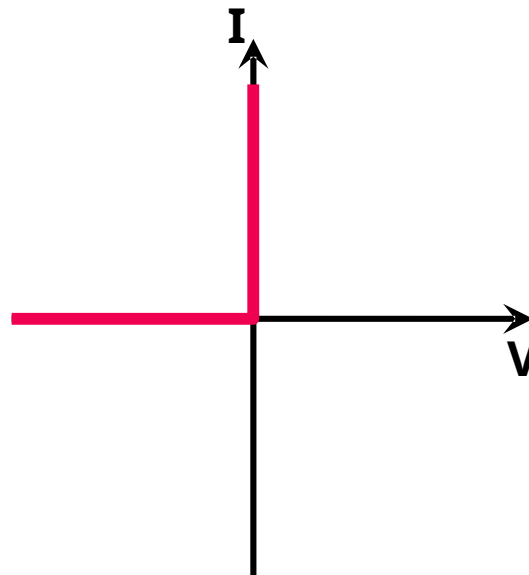
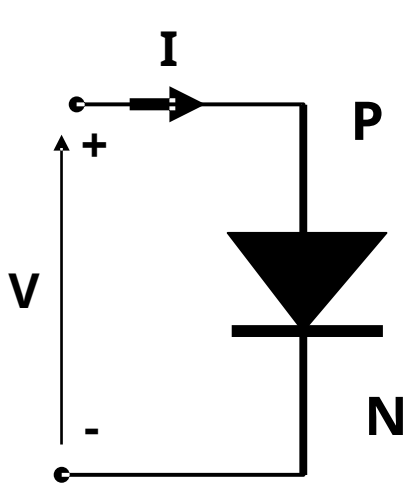

¡¡ PRESENTA UN COMPORTAMIENTO NO LINEAL !! >

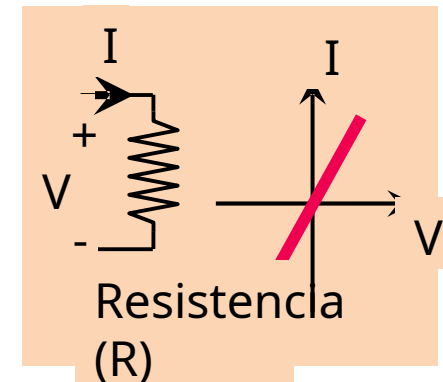

Un símil hidráulico podría ser una válvula anti-retorno (o **retención**), permite pasar el agua (**corriente**) en un único sentido.

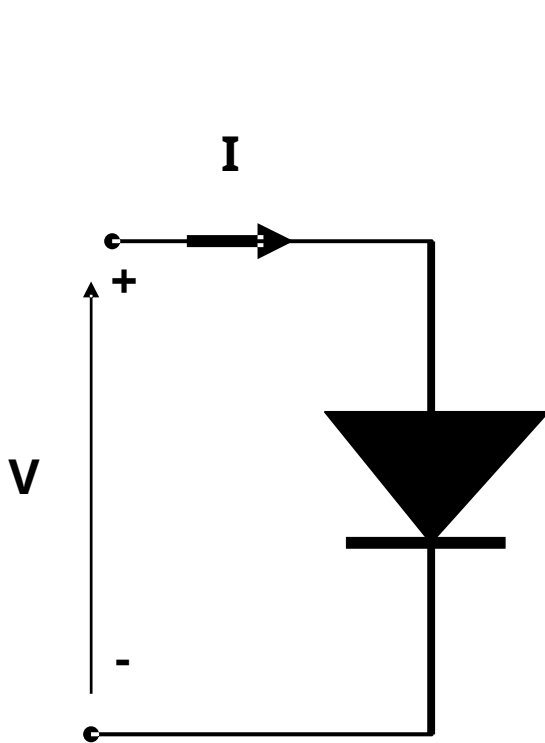

DIODO REAL

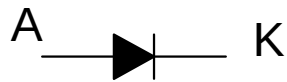
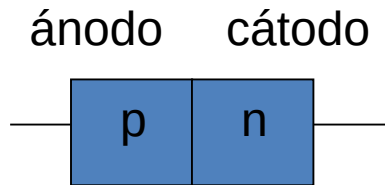

Símbolo

Silicio

Germanio

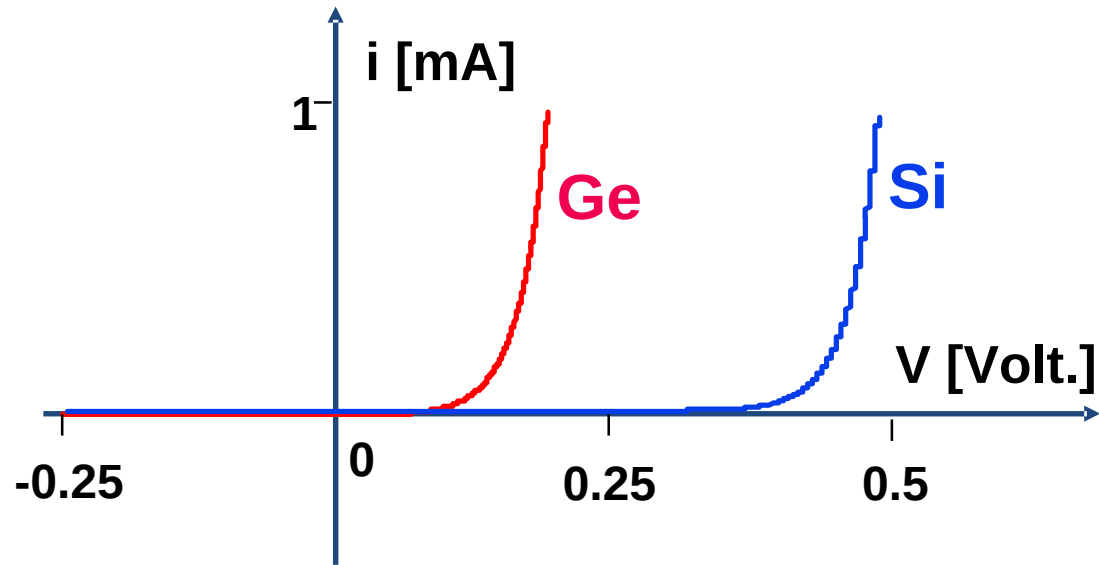

$$I_D = I_S e^{\frac{V_D q}{K T}} - 1$$

I_S = Corriente Saturación Inversa

K = Cte. Boltzman

V_D = Tensión diodo

q = carga del electrón

T = temperatura (°K)

I_D = Corriente diodo

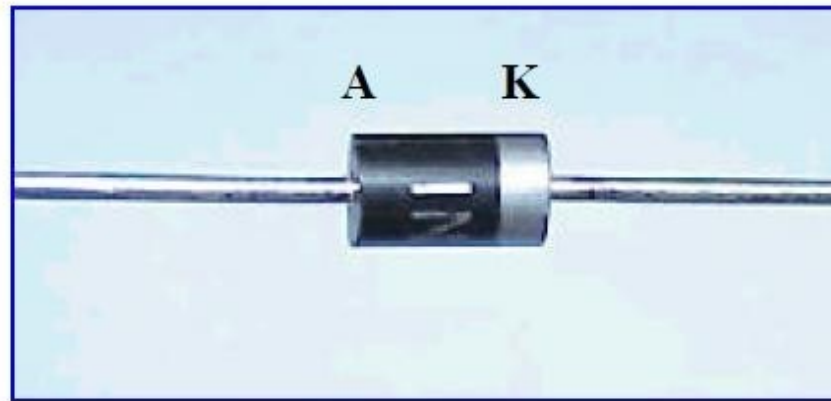

v

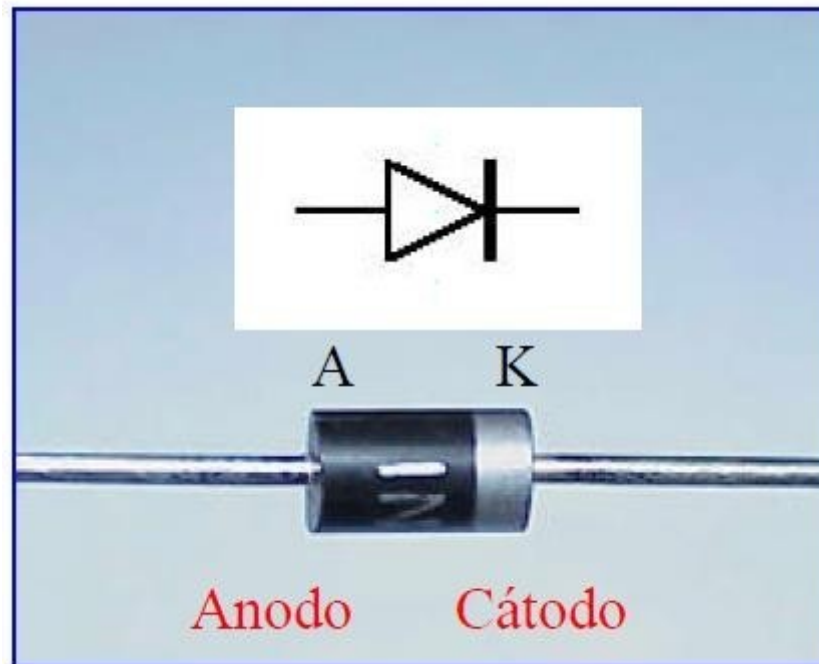

DIODO: DISTINTAS APROXIMACIONES

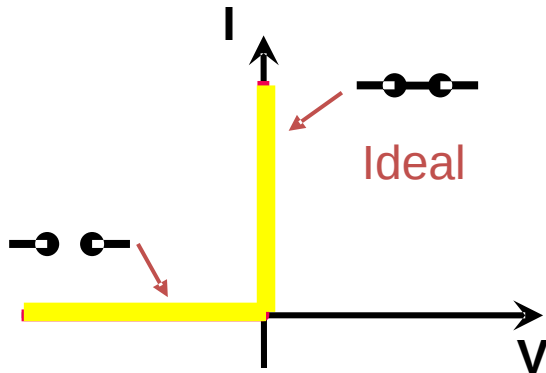

1ra Aproximación

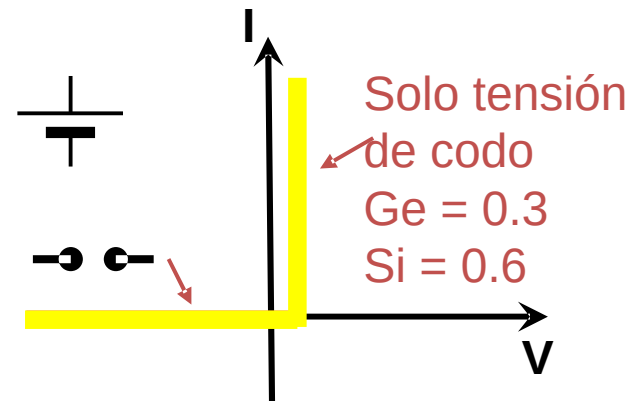

2da Aproximación

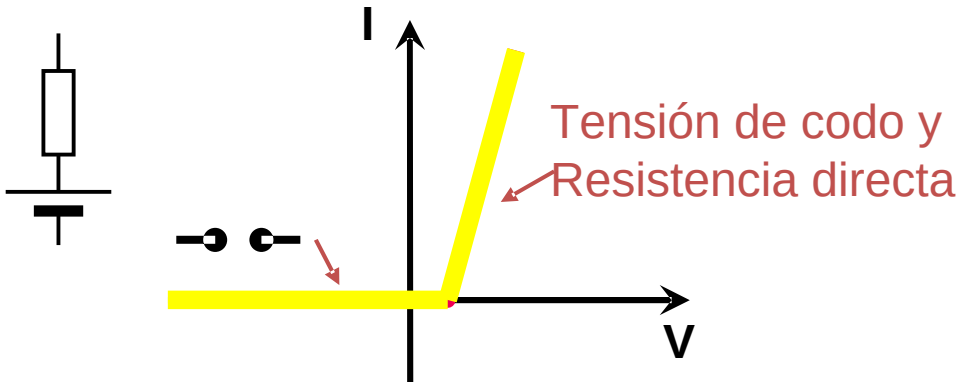

3ra Aproximación

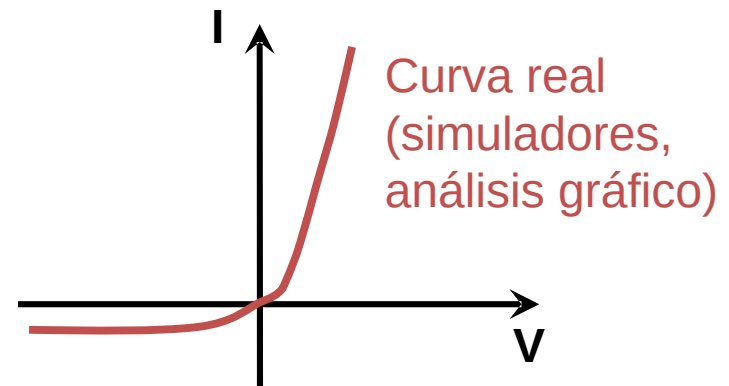

Modelado de diodos

Modelo Ideal: Primera Aproximación

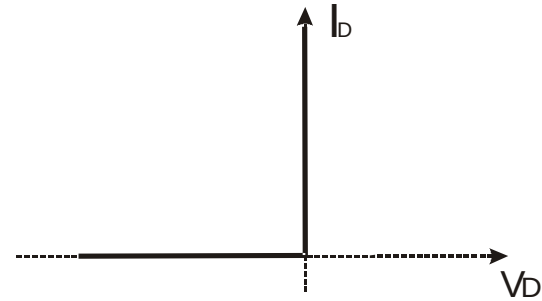

Modelo Simplificado: Segunda Aproximación

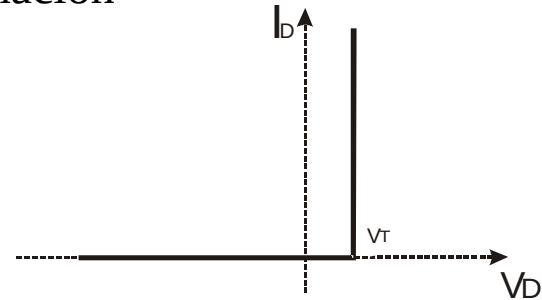
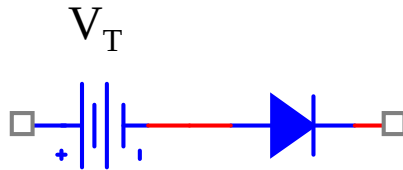

Modelo de segmentos lineales: Tercera Aproximación

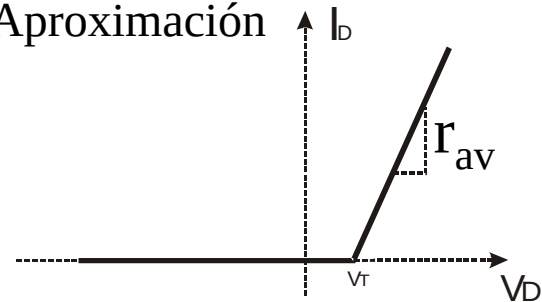
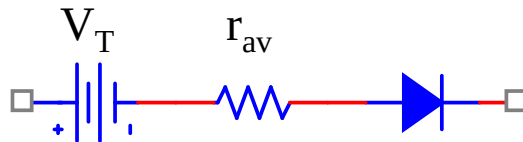

DIODO: LIMITACIONES

Tensión inversa máxima

Ruptura de la Unión por avalancha

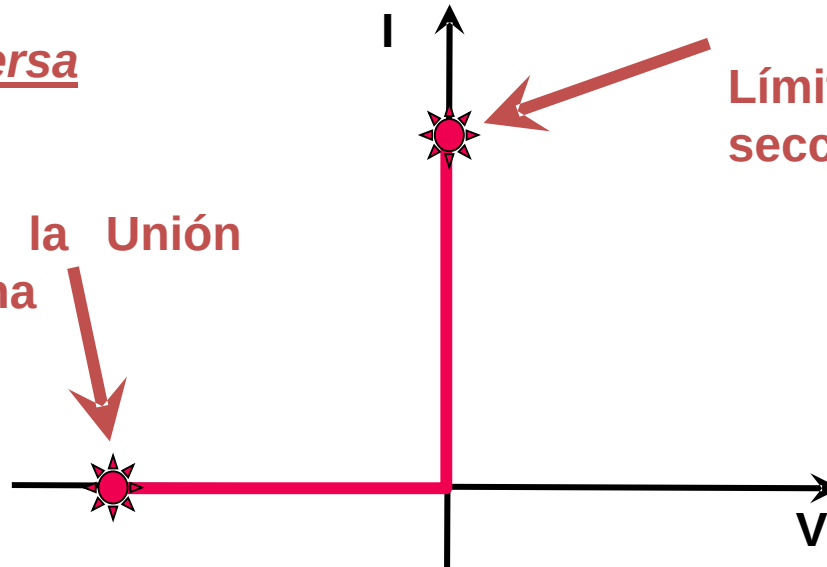

Corriente máxima

Límite térmico,
sección del conductor



600 V/6000 A



200 V /60 A

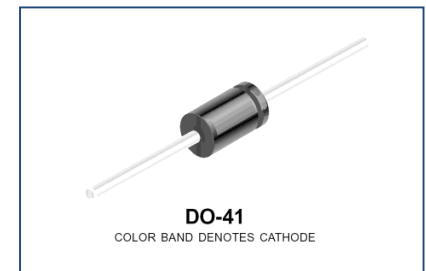

1000 V /1 A

DIODO: Parámetros facilitados por fabricantes



| | | |
|-------------------|-------|--------------------------|
| $V_R =$ | 1000V | Tensión inversa máxima |
| $I_{OMAX (AV)} =$ | 1A | Corriente directa máxima |
| $V_F =$ | 1V | Caída de Tensión directa |
| $I_R =$ | 50 nA | Corriente inversa |

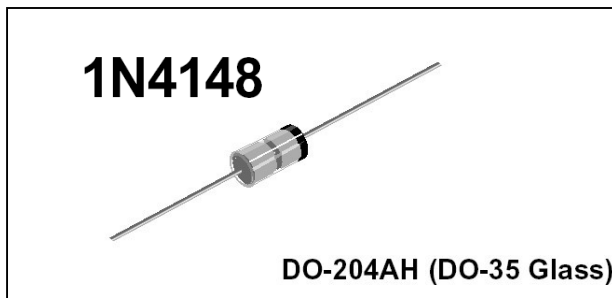

| | | |
|-------------------|-------|--------------------------|
| $V_R =$ | 100V | Tensión inversa máxima |
| $I_{OMAX (AV)} =$ | 150mA | Corriente directa máxima |
| $V_F =$ | 1V | Caída de Tensión directa |
| $I_R =$ | 25 nA | Corriente inversa |

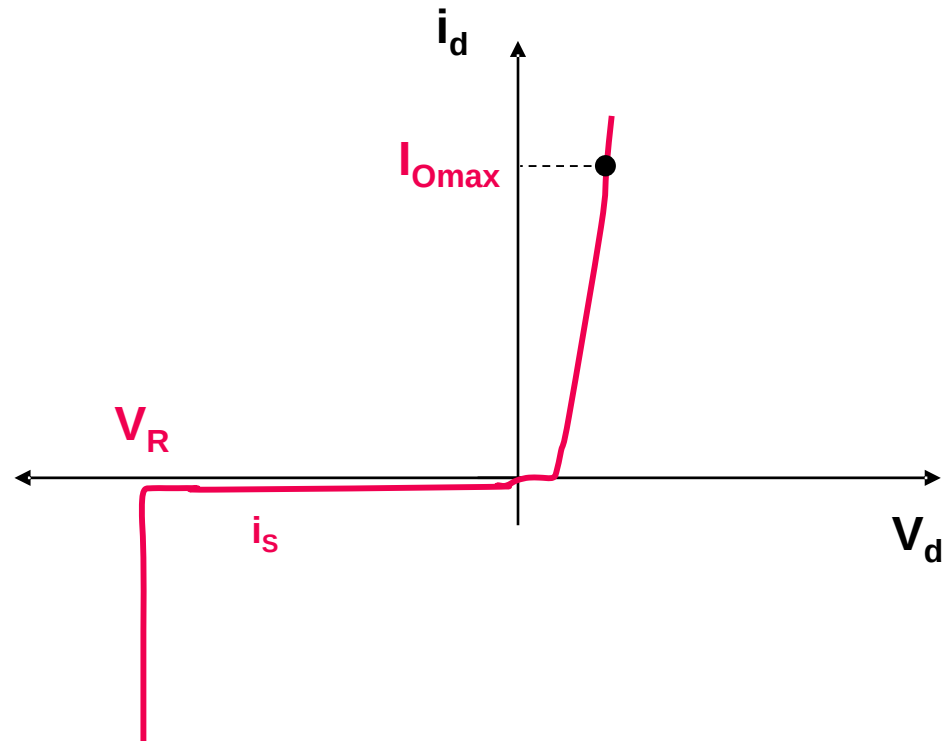

NOTA:

Se sugiere con un buscador obtener las hojas de características de un diodo (p.ej. 1N4007). Normalmente aparecerán varios fabricantes para el mismo componente.

RECTA DE CARGA Y PUNTO DE FUNCIONAMIENTO

CIRCUITO
LINEAL

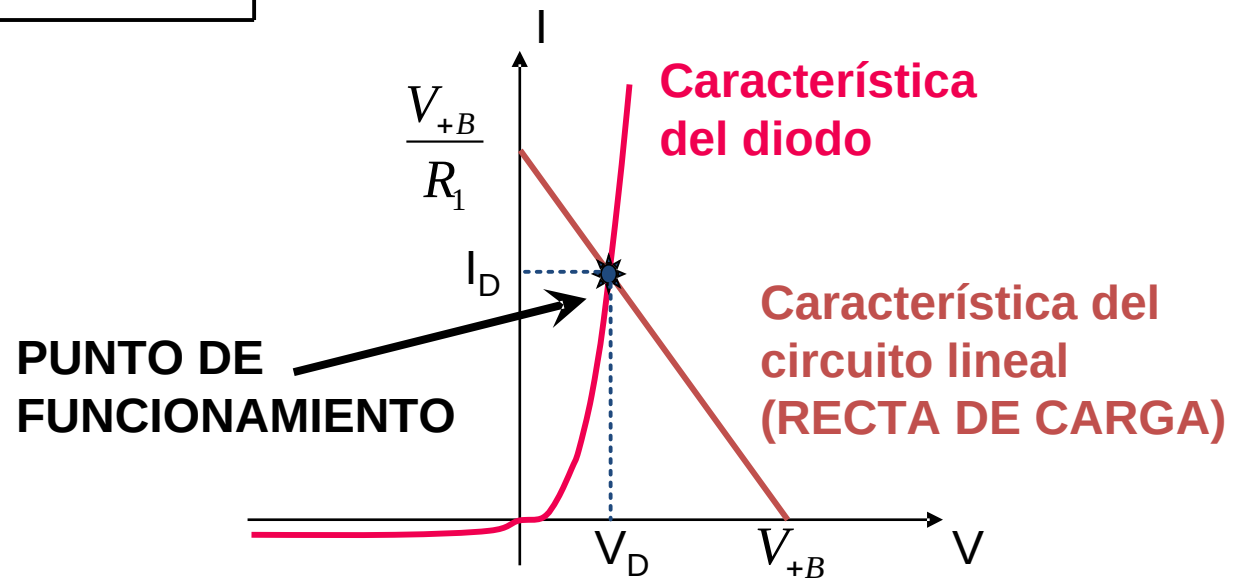
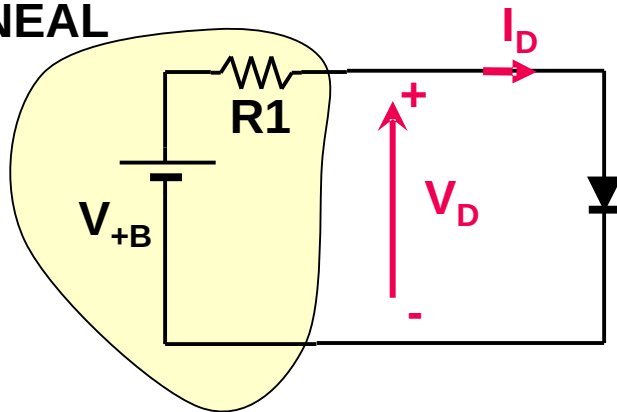

COMENTARIOS SOBRE CIRCUITOS

Los diodos (y el resto de dispositivos electrónicos) son dispositivos no lineales.

¡No se puede aplicar el principio de superposición!

EJEMPLO TÍPICO: RECTIFICADOR

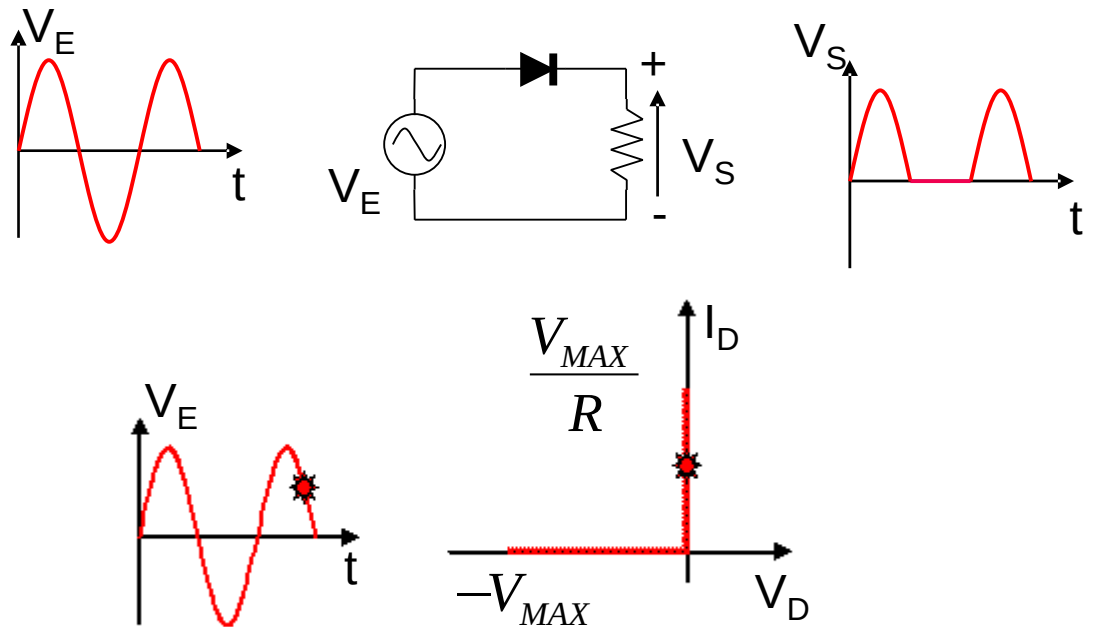

FIN